

No. 6952CP

Swing clamp, plug-in mounting

Double-acting,
max. operating pressure 350 bar,
min. operating pressure 40 bar.

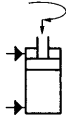

Order no.	Article no.	Clamping force at 350 bar Sp* [kN]	Clamping stroke M [mm]	Total stroke N [mm]	Vol. Sp [cm ³]	Vol. Lo [cm ³]	eff. piston area Sp [cm ²]	eff. piston area Lo [cm ²]	min. permitted clamping time * [s]	Q max. * [l/min]	Piston mass moment of inertia JK [kgm ²]	Weight [g]
556954	6952CP-06-21	6,0	12	23	5,7	10,3	2,51	4,52	0,35	0,7	0,00012193	725
556955	6952CP-06-22	6,0	12	23	5,7	10,3	2,51	4,52	0,35	0,7	0,00012193	725
556956	6952CP-08-21	8,0	12	24	7,2	14,7	3,01	6,15	0,32	1,0	0,00025865	1200
556957	6952CP-08-22	8,0	12	24	7,2	14,7	3,01	6,15	0,32	1,0	0,00025865	1200
556958	6952CP-15-21	15,0	15	30	15,8	30,5	5,27	10,17	0,49	2,0	0,00088178	2150
556959	6952CP-15-22	15,0	15	30	15,8	30,5	5,27	10,17	0,49	2,0	0,00088178	2150

Cl = clamping, Uncl = unclamp

* Specifications with clamping arm, standard

Design:

Cylinder barrel made of steel, hardened and burnished. Piston rod hardened. Piston rod with internal thread and clamp arm positioning. Wiper at the piston rod. Clamp arm not supplied as standard. Oil supply via oil channel in fixture body.

Application:

The swivel clamp is used in fixtures in which the workpiece must be freely accessible and inserted from above. Even workpieces with difficult shapes can be clamped using special clamp arms (available on request).

Features:

The swing motion is executed via three ball guides, thereby increasing positioning accuracy, repeat accuracy and service life.

Note:

The piston stroke is executed with spheres, so volume flow Q max. must be complied with. Clamping arm length and clamping arm weight must be strictly observed. No force may be applied to the piston when mounting accessories to it. To equalise height differences on the workpiece, the vertical clamping path must be 50% of the clamping stroke. When placing into operation, ensure that all air is bled from the system. To control the oil feed, the throttle/check valve no. 6916-12-01 can be optionally used with G1/8 and 6916-12-04 with G1/4. Other swivel angles are available on request.

Formula to determine the total mass moment of inertia and the volume flow:

total mass moment of inertia Jges. [kgm²]
Clamp arm mass moment of inertia JH [kgm²]
Piston mass moment of inertia JK [kgm²]
Clamp arm load mH [kg]
Centre of gravity distance Ls [m]
Jges. = JK + JH + mH x Ls² [kgm²]

Volume flow Qmax. [cm³/s]
Volume clamp Vol.sp [cm³]
Minimum permitted clamp time tmin. [s]
Qmax. = Vol.sp / tmin. [cm³/s]

Suitable clamp arms are 6951-XX.

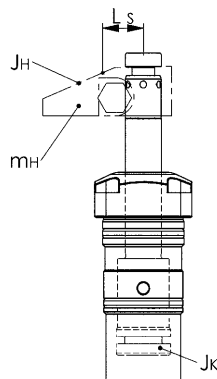

Dimensions:

Order no.	Article no.	dia. A	dia. A1	B	C	D	E	F	dia. G	dia. H	dia. H1	J x depth	L	M	N	P	Q	U	S	T	W	dia. X	Y1	Y2	ØAD	OR-1 O-ring Order No.	OR-2 O-ring Order No.
556954	6952CP-06-21	36	35	156,7	146,7	72,7	33,0	20	6,6	16	15,88	M10 x 14	11	12	23	43	23	45	33	73,3	8	4	16 - 20	45 - 73,3	3,2	321018	321018
556955	6952CP-06-22	36	35	156,7	146,7	72,7	33,0	20	6,6	16	15,88	M10 x 14	11	12	23	43	23	45	33	73,3	8	4	16 - 20	45 - 73,3	3,2	321018	321018
556956	6952CP-08-21	44	42	168,4	157,4	77,7	33,7	23	8,5	20	20,0	M10 x 14	10	12	24	54	27	50	40	78,3	9	4	16 - 24	53 - 78,3	4,8	409748	557639
556957	6952CP-08-22	44	42	168,4	157,4	77,7	33,7	23	8,5	20	20,0	M10 x 14	10	12	24	54	27	50	40	78,3	9	4	16 - 24	53 - 78,3	4,8	409748	557639
556958	6952CP-15-21	55	52	204,2	189,2	88,5	40,2	28	10,5	25	25,0	M12 x 14	14	15	30	67	25	53	50	89,3	10	4	16 - 22	56 - 89,3	4,8	321174	557640
556959	6952CP-15-22	55	52	204,2	189,2	88,5	40,2	28	10,5	25	25,0	M12 x 14	14	15	30	67	25	53	50	89,3	10	4	16 - 22	56 - 89,3	4,8	321174	557640

Installation dimensions:

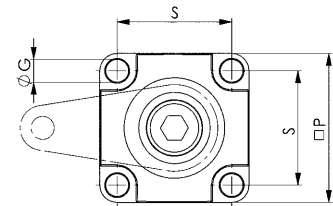
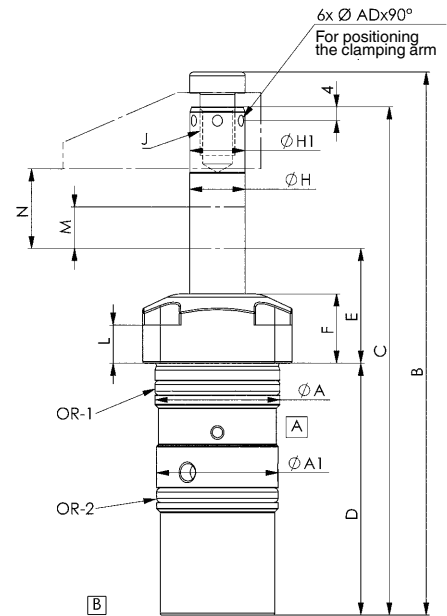
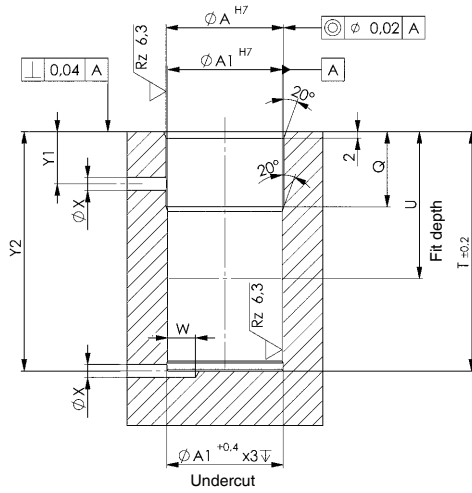

- A** = clamp
- B** = unclamp

Diagrams:

6952CP-06

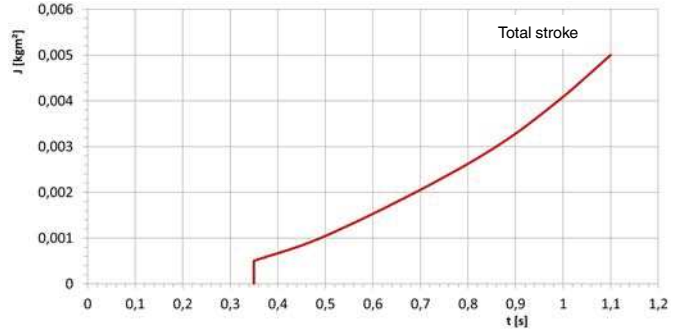
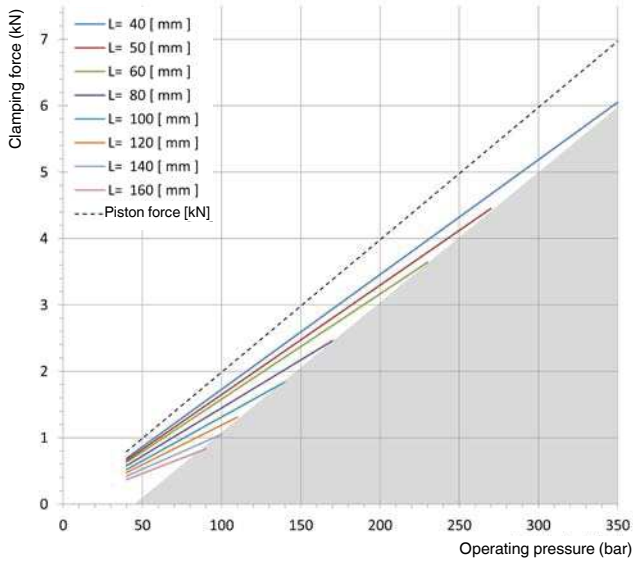

6952CP-08

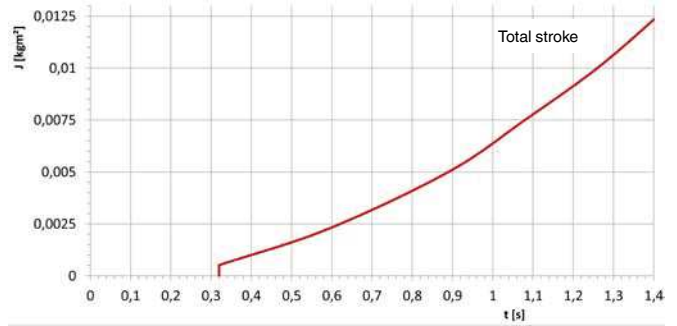
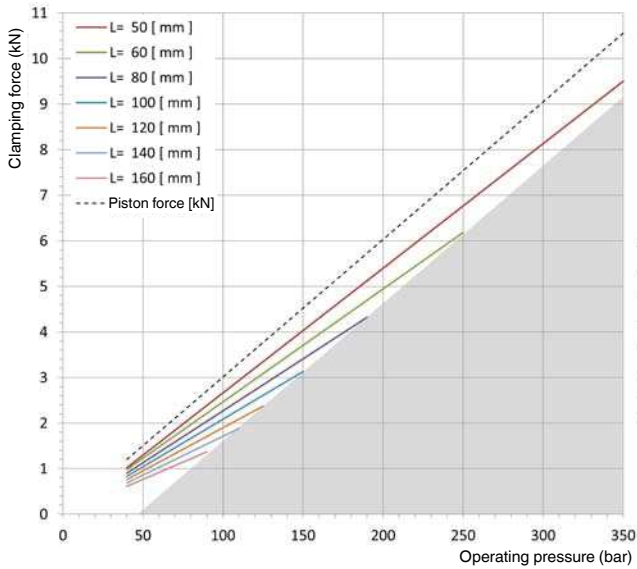

6952CP-15

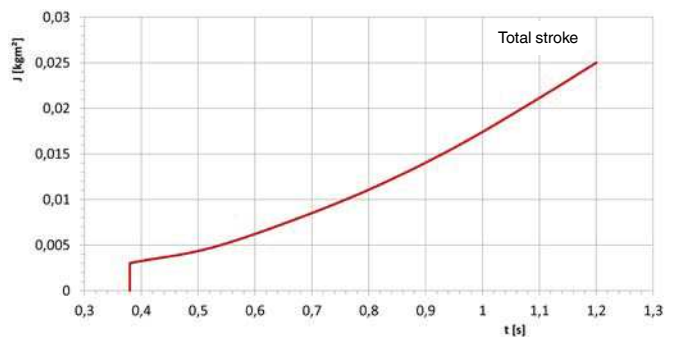
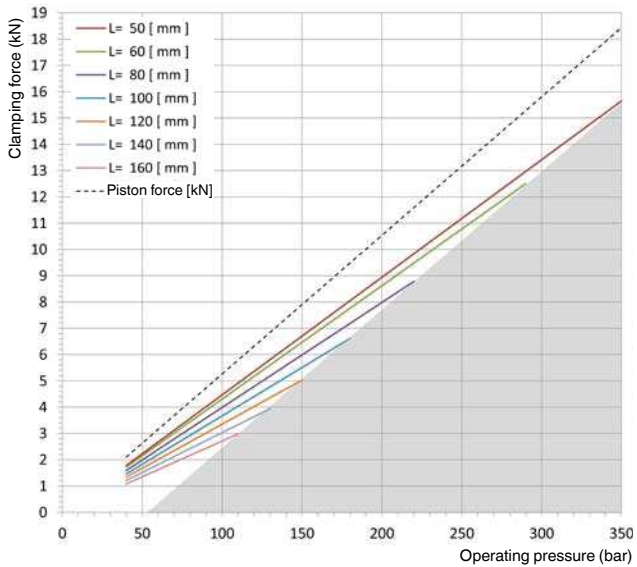

Subject to technical alterations.