

# ADAPTER IECEX-ATEX, RNC, IP66 / 68, NICKEL PLATED BRASS

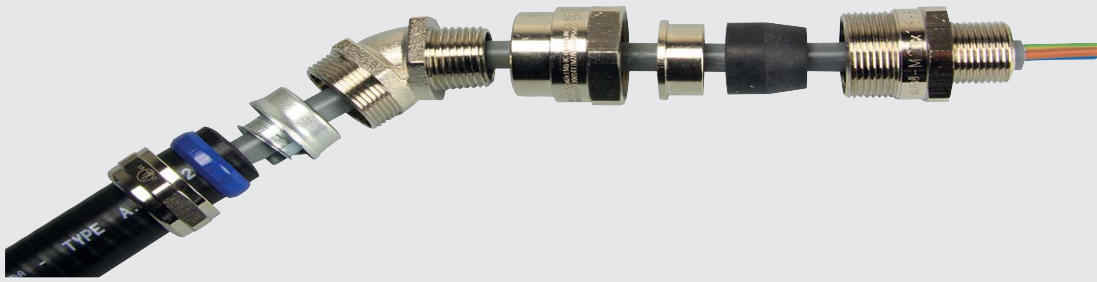

## Anamet IECEX-ATEX adapter fitting, type RNC and RAC, nickel plated brass

Type RNC IECEX-ATEX approved 45° or 90° nickel plated brass adapter, male one side, female other side, was originally developed to connect to threaded rigid conduit but is also used with a flexible metal conduit to protect unarmoured cable in a potentially explosive atmosphere. The connection with an Anaconda flexible conduit is made with a standard male 45° or 90° Anaconda, nickel plated brass, swivel fitting which is screwed into the female thread of the adapter. Since RNA cable hose fittings are available upto 1.1/4", the RNC 1.1/2" to 3" adapter in combination with Anaconda standard fittings can be used when larger sizes are required. Typical applications include motors, transformers, control equipment, Ex enclosures, terminal boxes and components etc., in the chemical and petrochemical, Oil and Gas, wood processing, bulk handling and food and pharma industries. Also available in a version for armoured cable (type RAC, pages 7-36 and 7-37).

### Material and Construction:

**Construction :** Nickel plated brass fitting, consisting of 4 parts (female body, pressure ring, sealing rubber and male body).

**Material:** Female body, pressure ring and male body are nickel plated brass and sealing rubber is from EPDM rubber. Also available in stainless steel AISI-316.

**Temperature:** -40 °C till +100 °C continuous. With silicone pressure rubber -65 °C till +220 °C continuous.

**Protection class:** Standard is IP66, with a flat seal between body and switchbox IP68.

**Colour:** Metal.

For unarmoured cable, IECEX-ATEX certified and marked;

RCN (type) (threadsize) IECEX INE 10.0010X Ex d/e I Mb IIC Gb Ex tb IIIC Db

CE 0080 INERIS 06ATEX0014X I M2 / II 2 GD, IP66 / IP68 EAC

RNC, ISO, IECEX-ATEX cable-adapter, nickel plated brass, EPDM seal

(-40 °C till +100°C)

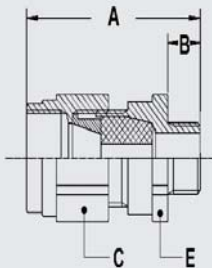

Thread	Thread	Clamping Range (mm)	Dimensions in mm					Standard Package	Article Number	Weight (Kg/100)
			A	B	C	D	E			
M20 x 1,5	NPT 1/2"	5,5 - 8	63	15	32	-	30	10	297.812.0	17,4
M20 x 1,5	NPT 1/2"	8 - 10,5	63	15	32	-	30	10	297.813.0	17,4
M20 x 1,5	NPT 1/2"	10,5 - 13	63	15	32	-	30	10	297.814.0	17,4
M25 x 1,5	NPT 3/4"	10,5 - 13	63	15	36	-	35	5	297.815.0	20,6
M25 x 1,5	NPT 3/4"	13 - 15,5	63	15	36	-	35	5	297.818.0	20,6
M25 x 1,5	NPT 3/4"	15,5 - 18	63	15	36	-	35	5	297.819.0	20,6
M32 x 1,5	NPT 1"	15 - 18	76	15	45	-	42	5	297.823.0	35,6
M32 x 1,5	NPT 1"	18 - 21	76	15	45	-	42	5	297.824.0	35,6
M32 x 1,5	NPT 1"	21 - 24	76	15	45	-	42	5	297.825.0	35,6
M40 x 1,5	NPT 1.1/4"	21 - 24	79	15	50	-	48	2	297.829.0	43,1
M40 x 1,5	NPT 1.1/4"	24 - 27	79	15	50	-	48	2	297.830.0	43,1
M40 x 1,5	NPT 1.1/4"	27 - 30	79	15	50	-	48	2	297.831.0	43,1
M50 x 1,5	NPT 1.1/2"	30 - 33	79	15	57	-	55	2	297.843.0	56,8
M50 x 1,5	NPT 1.1/2"	33 - 36	79	15	57	-	55	2	297.844.0	56,8
M63 x 1,5	NPT 2"	36 - 39	80	15	68	-	68	2	297.851.0	78,4
M63 x 1,5	NPT 2"	39 - 42	80	15	68	-	68	2	297.852.0	78,4
M63 x 1,5	NPT 2"	42 - 45	80	15	68	-	68	2	297.853.0	78,4
M75 x 1,5	NPT 2.1/2"	45 - 48	91	15	80	-	80	1	297.854.0	112,4
M75 x 1,5	NPT 2.1/2"	48 - 51	91	15	80	-	80	1	297.855.0	112,4
M75 x 1,5	NPT 2.1/2"	51 - 54	91	15	80	-	80	1	297.856.0	112,4
M90 x 2	NPT 3"	54 - 58	103	20	102	-	100	1	297.857.0	223,5
M90 x 2	NPT 3"	58 - 62	103	20	102	-	100	1	297.858.0	223,5

# ADAPTER IECEX-ATEX, RNC, IP66 / 68, NICKEL PLATED BRASS

For unarmoured cable, IECEX-ATEX certified and marked;

 RCN (type) (threadsize) IECEX INE 10.0010X Ex d/e I Mb IIC Gb Ex tb IIIC Db  
 0080 INERIS 06ATEX0014X I M2 / II 2 GD, IP66 / IP68 EAC

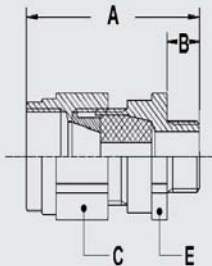

RNC, NPT, IECEX-ATEX cable-adapter, nickel plated brass,  
 EPDM seal

(-40 °C till +100°C)



Thread	Thread	Clamping Range (mm)	Dimensions in mm					Standard Package	Article Number	Weight (Kg/100)
			A	B	C	D	E			
NPT 1/2"	NPT 1/2"	5,5 - 8	66	18	32	-	30	10	297.912.0	17,4
NPT 1/2"	NPT 1/2"	8 - 10,5	66	18	32	-	30	10	297.913.0	17,4
NPT 1/2"	NPT 1/2"	10,5 - 13	66	18	32	-	30	10	297.914.0	17,4
NPT 3/4"	NPT 3/4"	10,5 - 13	66	18	36	-	35	5	297.915.0	20,6
NPT 3/4"	NPT 3/4"	13 - 15,5	66	18	36	-	35	5	297.918.0	20,6
NPT 3/4"	NPT 3/4"	15,5 - 18	66	18	36	-	35	5	297.919.0	20,6
NPT 1"	NPT 1"	15 - 18	83	22	45	-	42	5	297.923.0	35,6
NPT 1"	NPT 1"	18 - 21	83	22	45	-	42	5	297.924.0	35,6
NPT 1"	NPT 1"	21 - 24	83	22	45	-	42	5	297.925.0	35,6
NPT 1.1/4"	NPT 1.1/4"	21 - 24	86	22	50	-	48	2	297.929.0	43,1
NPT 1.1/4"	NPT 1.1/4"	24 - 27	86	22	50	-	48	2	297.930.0	43,1
NPT 1.1/4"	NPT 1.1/4"	27 - 30	86	22	50	-	48	2	297.931.0	43,1
NPT 1.1/2"	NPT 1.1/2"	30 - 33	88	24	57	-	55	2	297.943.0	56,8
NPT 1.1/2"	NPT 1.1/2"	33 - 36	88	24	57	-	55	2	297.944.0	56,8
NPT 2"	NPT 2"	36 - 39	89	24	68	-	68	2	297.951.0	78,4
NPT 2"	NPT 2"	39 - 42	89	24	68	-	68	2	297.952.0	78,4
NPT 2"	NPT 2"	42 - 45	89	24	68	-	68	2	297.953.0	78,4
NPT 2.1/2"	NPT 2.1/2"	45 - 48	104	28	80	-	80	1	297.954.0	112,4
NPT 2.1/2"	NPT 2.1/2"	48 - 51	104	28	80	-	80	1	297.955.0	112,4
NPT 2.1/2"	NPT 2.1/2"	51 - 54	104	28	80	-	80	1	297.956.0	112,4
NPT 3"	NPT 3"	54 - 58	111	28	102	-	100	1	297.957.0	223,5
NPT 3"	NPT 3"	58 - 62	111	28	102	-	100	1	297.958.0	223,5

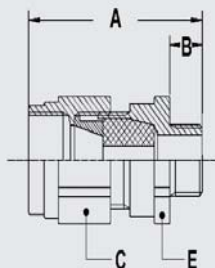

RNC, Pg, IECEX-ATEX cable-adapter, nickel plated brass,  
 EPDM seal

(-40 °C till +100°C)



Thread	Thread	Clamping Range (mm)	Dimensions in mm					Standard Package	Article Number	Weight (Kg/100)
			A	B	C	D	E			
Pg 11	NPT 1/2"	5,5 - 8	63	15	32	-	30	10	297.611.0	17,4
Pg 13,5	NPT 1/2"	5,5 - 8	63	15	32	-	30	10	297.612.0	17,4
Pg 13,5	NPT 1/2"	8 - 10,5	63	15	32	-	30	10	297.613.0	17,4
Pg 13,5	NPT 1/2"	10,5 - 13	63	15	32	-	30	10	297.614.0	17,4
Pg 16	NPT 3/4"	10,5 - 13	63	15	36	-	35	5	297.615.0	20,6
Pg 16	NPT 3/4"	13 - 15,5	63	15	36	-	35	5	297.618.0	20,6
Pg 16	NPT 3/4"	15,5 - 18	63	15	36	-	35	5	297.619.0	20,6
Pg 21	NPT 1"	15 - 18	76	15	45	-	42	5	297.623.0	35,6
Pg 21	NPT 1"	18 - 21	76	15	45	-	42	5	297.624.0	35,6
Pg 21	NPT 1"	21 - 24	76	15	45	-	42	5	297.625.0	35,6
Pg 29	NPT 1.1/4"	21 - 24	81	17	50	-	48	2	297.629.0	43,1
Pg 29	NPT 1.1/4"	24 - 27	81	17	50	-	48	2	297.630.0	43,1
Pg 29	NPT 1.1/4"	27 - 30	81	17	50	-	48	2	297.631.0	43,1
Pg 36	NPT 1.1/2"	30 - 33	81	17	57	-	55	2	297.643.0	56,8
Pg 36	NPT 1.1/2"	33 - 36	81	17	57	-	55	2	297.644.0	56,8
Pg 48	NPT 2"	36 - 39	83	18	68	-	68	2	297.651.0	78,4
Pg 48	NPT 2"	39 - 42	83	18	68	-	68	2	297.652.0	78,4
Pg 48	NPT 2"	42 - 45	83	18	68	-	68	2	297.653.0	78,4

# ADAPTER IECEX-ATEX, RAC, IP66 / 68, NICKEL PLATED BRASS

For armoured cable, IECEX-ATEX certified and marked;

▲ RCN (type) (threadsize) IECEX INE 10.0010X Ex d/e I Mb IIC Gb Ex tb IIIC Db  
 ⚡ CE 0080 INERIS 06ATEX0014X I M2 / II 2 GD, IP66 / IP68 EAC

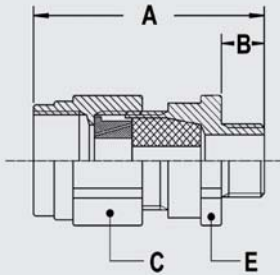

RAC, ISO, IECEX-ATEX EMC cable-adapter, nickel plated brass, EPDM seal

(-40 °C till +100 °C)



Thread	Thread	Clamping Range (mm)	Dimensions in mm					Standard Package	Article Number	Weight (Kg/100)
			A	B	C	D	E			
M20 x 1,5	NPT 1/2"	5,5 - 8	63	15	32	-	30	10	839.812.0	17,4
M20 x 1,5	NPT 1/2"	8 - 10,5	63	15	32	-	30	10	839.813.0	17,4
M20 x 1,5	NPT 1/2"	10,5 - 13	63	15	32	-	30	10	839.814.0	17,4
M25 x 1,5	NPT 3/4"	10,5 - 13	63	15	36	-	35	5	839.815.0	20,6
M25 x 1,5	NPT 3/4"	13 - 15,5	63	15	36	-	35	5	839.818.0	20,6
M25 x 1,5	NPT 3/4"	15,5 - 18	63	15	36	-	35	5	839.819.0	20,6
M32 x 1,5	NPT 1"	15 - 18	76	15	45	-	42	5	839.823.0	35,6
M32 x 1,5	NPT 1"	18 - 21	76	15	45	-	42	5	839.824.0	35,6
M32 x 1,5	NPT 1"	21 - 24	76	15	45	-	42	5	839.825.0	35,6
M40 x 1,5	NPT 1.1/4"	21 - 24	79	15	50	-	48	2	839.829.0	43,1
M40 x 1,5	NPT 1.1/4"	24 - 27	79	15	50	-	48	2	839.830.0	43,1
M40 x 1,5	NPT 1.1/4"	27 - 30	79	15	50	-	48	2	839.831.0	43,1
M50 x 1,5	NPT 1.1/2"	30 - 33	79	15	57	-	55	2	839.843.0	56,8
M50 x 1,5	NPT 1.1/2"	33 - 36	79	15	57	-	55	2	839.844.0	56,8
M63 x 1,5	NPT 2"	36 - 39	80	15	68	-	68	2	839.851.0	78,4
M63 x 1,5	NPT 2"	39 - 42	80	15	68	-	68	2	839.852.0	78,4
M63 x 1,5	NPT 2"	42 - 45	80	15	68	-	68	2	839.853.0	78,4
M75 x 1,5	NPT 2.1/2"	45 - 48	91	15	80	-	80	1	839.854.0	112,4
M75 x 1,5	NPT 2.1/2"	48 - 51	91	15	80	-	80	1	839.855.0	112,4
M75 x 1,5	NPT 2.1/2"	51 - 54	91	15	80	-	80	1	839.856.0	112,4
M90 x 2	NPT 3"	54 - 58	103	20	102	-	100	1	839.857.0	223,5
M90 x 2	NPT 3"	58 - 62	103	20	102	-	100	1	839.858.0	223,5



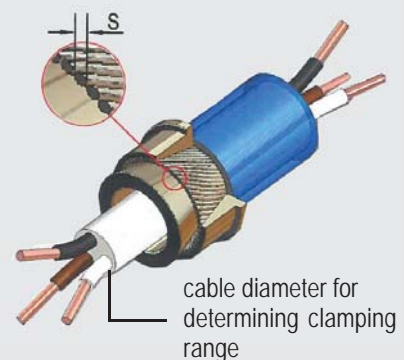

## Special information for EMC cable-hose-fittings

1. In case of EMC versions, the cable diameter needed to determine the clamping range, is not the outside diameter of the cable but the diameter of the cable without the braiding.
2. In case of EMC versions with a wire diameter (S) from 1,0 till 2,5 mm (type SWA, Steel Wire Armour) a special 2 piece clamping ring (reduced cone) must be ordered.



# ADAPTER IECEx-ATEX, RAC, IP66 / 68, NICKEL PLATED BRASS

For armoured cable, IECEx-ATEX certified and marked;

 RCN (type) (threadsize) IECEx INE 10.0010X Ex d/e I Mb IIC Gb Ex tb IIIC Db  
  0080 INERIS 06ATEX0014X I M2 / II 2 GD, IP66 / IP68  

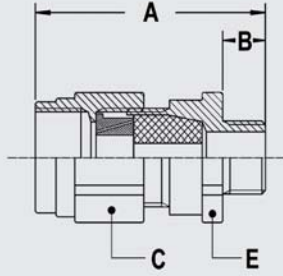

RAC, NPT, IECEx-ATEX, EMC cable-adaptor, nickel plated brass, EPDM seal  
 (-40 °C till +100°C)



Thread	Thread	Clamping Range (mm)	Dimensions in mm					Standard Package	Article Number	Weight (Kg/100)
			A	B	C	D	E			
NPT 1/2"	NPT 1/2"	5,5 - 8	66	18	32	-	30	10	839.912.0	17,4
NPT 1/2"	NPT 1/2"	8 - 10,5	66	18	32	-	30	10	839.913.0	17,4
NPT 1/2"	NPT 1/2"	10,5 - 13	66	18	32	-	30	10	839.914.0	17,4
NPT 3/4"	NPT 3/4"	10,5 - 13	66	18	36	-	35	5	839.915.0	20,6
NPT 3/4"	NPT 3/4"	13 - 15,5	66	18	36	-	35	5	839.918.0	20,6
NPT 3/4"	NPT 3/4"	15,5 - 18	66	18	36	-	35	5	839.919.0	20,6
NPT 1"	NPT 1"	15 - 18	83	22	45	-	42	5	839.923.0	35,6
NPT 1"	NPT 1"	18 - 21	83	22	45	-	42	5	839.924.0	35,6
NPT 1"	NPT 1"	21 - 24	83	22	45	-	42	5	839.925.0	35,6
NPT 1.1/4"	NPT 1.1/4"	21 - 24	86	22	50	-	48	2	839.929.0	43,1
NPT 1.1/4"	NPT 1.1/4"	24 - 27	86	22	50	-	48	2	839.930.0	43,1
NPT 1.1/4"	NPT 1.1/4"	27 - 30	86	22	50	-	48	2	839.931.0	43,1
NPT 1.1/2"	NPT 1.1/2"	30 - 33	88	24	57	-	55	2	839.943.0	56,8
NPT 1.1/2"	NPT 1.1/2"	33 - 36	88	24	57	-	55	2	839.944.0	56,8
NPT 2"	NPT 2"	36 - 39	89	24	68	-	68	2	839.951.0	78,4
NPT 2"	NPT 2"	39 - 42	89	24	68	-	68	2	839.952.0	78,4
NPT 2"	NPT 2"	42 - 45	89	24	68	-	68	2	839.953.0	78,4
NPT 2.1/2"	NPT 2.1/2"	45 - 48	104	28	80	-	80	1	839.954.0	112,4
NPT 2.1/2"	NPT 2.1/2"	48 - 51	104	28	80	-	80	1	839.955.0	112,4
NPT 2.1/2"	NPT 2.1/2"	51 - 54	104	28	80	-	80	1	839.956.0	112,4
NPT 3"	NPT 3"	54 - 58	111	28	102	-	100	1	839.957.0	223,5
NPT 3"	NPT 3"	58 - 62	111	28	102	-	100	1	839.958.0	223,5

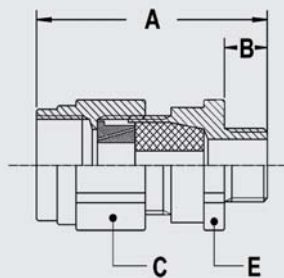

RAC, Pg, IECEx-ATEX, EMC cable-adaptor, nickel plated brass, EPDM seal  
 (-40 °C till +100°C)



Thread	Thread	Clamping Range (mm)	Dimensions in mm					Standard Package	Article Number	Weight (Kg/100)
			A	B	C	D	E			
Pg 11	NPT 1/2"	5,5 - 8	63	15	32	-	30	10	839.611.0	17,4
Pg 13,5	NPT 1/2"	5,5 - 8	63	15	32	-	30	10	839.612.0	17,4
Pg 13,5	NPT 1/2"	8 - 10,5	63	15	32	-	30	10	839.613.0	17,4
Pg 13,5	NPT 1/2"	10,5 - 13	63	15	32	-	30	10	839.614.0	17,4
Pg 16	NPT 3/4"	10,5 - 13	63	15	36	-	35	5	839.615.0	20,6
Pg 16	NPT 3/4"	13 - 15,5	63	15	36	-	35	5	839.618.0	20,6
Pg 16	NPT 3/4"	15,5 - 18	63	15	36	-	35	5	839.619.0	20,6
Pg 21	NPT 1"	15 - 18	76	15	45	-	42	5	839.623.0	35,6
Pg 21	NPT 1"	18 - 21	76	15	45	-	42	5	839.624.0	35,6
Pg 21	NPT 1"	21 - 24	76	15	45	-	42	5	839.625.0	35,6
Pg 29	NPT 1.1/4"	21 - 24	81	17	50	-	48	2	839.629.0	43,1
Pg 29	NPT 1.1/4"	24 - 27	81	17	50	-	48	2	839.630.0	43,1
Pg 29	NPT 1.1/4"	27 - 30	81	17	50	-	48	2	839.631.0	43,1
Pg 36	NPT 1.1/2"	30 - 33	81	17	57	-	55	2	839.643.0	56,8
Pg 36	NPT 1.1/2"	33 - 36	81	17	57	-	55	2	839.644.0	56,8
Pg 48	NPT 2"	36 - 39	83	18	68	-	68	2	839.651.0	78,4
Pg 48	NPT 2"	39 - 42	83	18	68	-	68	2	839.652.0	78,4
Pg 48	NPT 2"	42 - 45	83	18	68	-	68	2	839.653.0	78,4

General Index  
 Anaconda Multiflex  
 Anaconda Multitite  
 Anaconda Sealrite  
 Anaconda Sealrite Spec.  
 Anaconda Fittings  
 Anaconda Accessories  
 Anaconda IECEx - ATEX

# ADAPTER IECEx-ATEX, RNC, IP66 / 68, NICKEL PLATED BRASS

Anaconda fittings, nickel plated brass, for combination with adapter type RNC / RAC

The connection with an Anaconda conduit is made through a standard male Anaconda swivel fitting 45° or 90° which is screwed into the female thread of the adapter. Because RNA cable hose fittings are available only till 1.1/4", if a solution for big sizes is needed, it is also possible to use the RNC / RAC adapter from 1.1/2" up to 3" size in combination with Anaconda standard straight fittings.

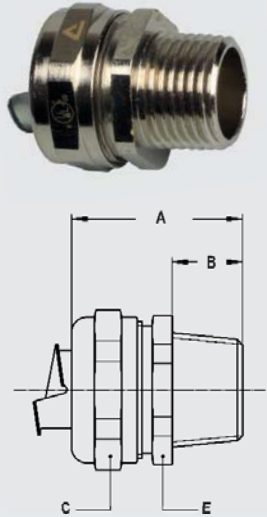

NPT straight fitting, compact, male, nickel plated brass



Thread NPT	Sealtite Size (NW)	Min. Internal Bore (mm)	Dimensions in mm					Standard Package	Article Number	Weight (Kg/100)
			A	B	C	D	E			
NPT 1/2"	3/8"	11,0	35	14	26	-	24	10	714.012.1	4,4
NPT 1/2"	1/2"	14,5	36	14	29	-	27	10	714.016.1	5,0
NPT 3/4"	3/4"	19,4	37	14	35	-	33	5	714.020.1	7,0
NPT 1"	1"	24,7	40	16	45	-	42	5	714.026.1	12,6
NPT 1.1/4"	1.1/4"	33,3	43	16	53	-	50	2	714.035.1	16,8
NPT 1.1/2"	1.1/2"	38,0	50	18	62	-	58	2	714.040.1	25,8
NPT 2"	2"	49,0	56	20	76	-	72	2	714.050.1	41,2
NPT 2.1/2"	2.1/2"	60,7	67	25	90	-	85	1	714.063.1*	83,6
NPT 3"	3"	75,5	73	27	108	-	102	1	714.075.1*	113,9

\* Size NPT 2.1/2" and NPT 3" are without UL/CSA.

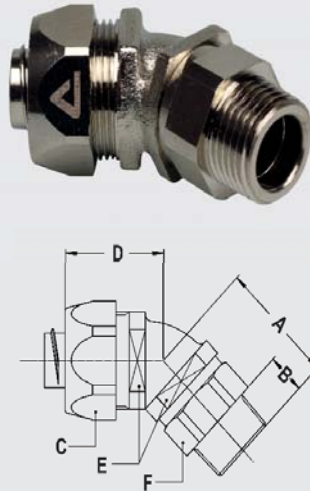

NPT 45° swivel fitting, male, nickel plated brass



Thread ISO	Sealtite Size (NW)	Min. Internal Bore (mm)	Dimensions in mm						Standard Package	Article Number	Weight (Kg/100)
			A	B	C	D	E	F			
NPT 1/2"	3/8"	10,4	36	12	26	28	22	22	10	819.412.0	11,5
NPT 1/2"	1/2"	13,8	36	12	29	30	27	25	10	819.416.0	14,0
NPT 3/4"	3/4"	17,4	39	12	35	32	33	31	5	819.420.0	22,0
NPT 1"	1"	23,4	42	13	45	37	42	38	5	819.426.0	37,0

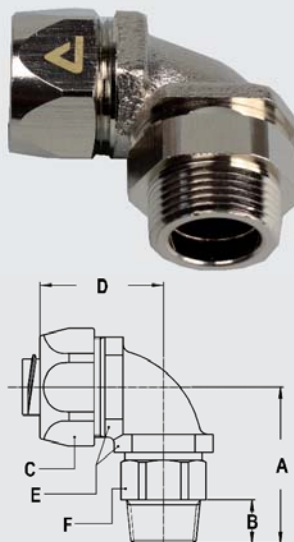

NPT 90° swivel fitting, male, nickel plated brass



Thread NPT	Sealtite Size (NW)	Min. Internal Bore (mm)	Dimensions in mm						Standard Package	Article Number	Weight (Kg/100)
			A	B	C	D	E	F			
NPT 1/2"	3/8"	10,4	41	12	26	35	22	22	10	819.912.0	12,0
NPT 1/2"	1/2"	13,8	41	12	29	37	27	25	10	819.916.0	14,0
NPT 3/4"	3/4"	17,4	48	12	35	44	33	31	5	819.920.0	23,5
NPT 1"	1"	23,4	56	13	45	55	42	38	5	819.926.0	42,0

# ADAPTER IECEX-ATEX, RNC-316, IP66 / 68, STAINLESS STEEL



## Anamet IECEX-ATEX adapter fitting, type RNC-316 and RAC-316, stainless steel AISI-316

Type RNC-316, IECEX-ATEX approved stainless steel adapter fittings, male one side, female other side, were originally developed to connect to threaded rigid conduit but are also used with a flexible metal conduit to protect unarmoured cable in a potentially explosive atmosphere. The use of stainless steel materials ensures good resistance to corrosion and chemicals in harsh environments. Connection to an Anaconda flexible conduit is made with a standard male 45°, 90°, swivel or fixed fitting which is screwed into the female thread of the adapter. Since RNA-316 cable hose fittings are available upto 1.1/4", the RNC-316 1.1/2" to 3" adapter in combination with Anaconda stainless steel fittings can be used when larger sizes are required. Typical applications include motors, transformers, control equipment, Ex enclosures, terminal boxes and components etc., in the chemical and petrochemical, Oil and Gas, wood processing, bulk handling and food and pharma industries. Also available in a version for armoured cable (type RAC-316, see pages 7-41 and 7-42).

### Material and Construction:

**Construction :** Stainless steel AISI-316 fitting, consisting of 4 parts (female body, pressure ring, sealing rubber and male body).

**Material:** Female body and male body are stainless steel AISI-316, the pressure ring is nickel plated brass and sealing rubber is from EPDM rubber.

**Temperature:** -40 °C till +100 °C continuous. With silicone sealing rubber -65 °C till +220 °C continuous.

**Protection class:** Standard is IP66, with a flat seal between body and switchbox IP68.

**Colour:** Metal.

For unarmoured cable, IECEX-ATEX certified and marked;

⚠ RCN (type) (threadsize) IECEX INE 10.0010X Ex d/e I Mb IIC Gb Ex tb IIIC Db  
 ⚠ CE 0080 INERIS 06ATEX0014X I M2 / II 2 GD, IP66 / IP68 EAC

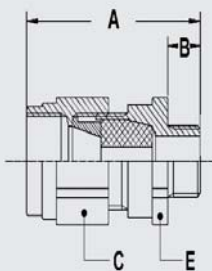

RNC-316, ISO, IECEX-ATEX cable-adapter, stainless steel  
 AISI-316, EPDM seal (-40 °C till +100°C)



Thread	Thread	Clamping Range (mm)	Dimensions in mm					Standard Package	Article Number	Weight (Kg/100)
			A	B	C	D	E			
M20 x 1,5	NPT 1/2"	5,5 - 8	63	15	32	-	30	10	297.812.9	17,4
M20 x 1,5	NPT 1/2"	8 - 10,5	63	15	32	-	30	10	297.813.9	17,4
M20 x 1,5	NPT 1/2"	10,5 - 13	63	15	32	-	30	10	297.814.9	17,4
M25 x 1,5	NPT 3/4"	10,5 - 13	63	15	36	-	35	5	297.815.9	20,6
M25 x 1,5	NPT 3/4"	13 - 15,5	63	15	36	-	35	5	297.818.9	20,6
M25 x 1,5	NPT 3/4"	15,5 - 18	63	15	36	-	35	5	297.819.9	20,6
M32 x 1,5	NPT 1"	15 - 18	76	15	45	-	42	5	297.823.9	35,6
M32 x 1,5	NPT 1"	18 - 21	76	15	45	-	42	5	297.824.9	35,6
M32 x 1,5	NPT 1"	21 - 24	76	15	45	-	42	5	297.825.9	35,6
M40 x 1,5	NPT 1.1/4"	21 - 24	79	15	50	-	48	2	297.829.9	43,1
M40 x 1,5	NPT 1.1/4"	24 - 27	79	15	50	-	48	2	297.830.9	43,1
M40 x 1,5	NPT 1.1/4"	27 - 30	79	15	50	-	48	2	297.831.9	43,1
M50 x 1,5	NPT 1.1/2"	30 - 33	79	15	57	-	55	2	297.843.9	56,8
M50 x 1,5	NPT 1.1/2"	33 - 36	79	15	57	-	55	2	297.844.9	56,8
M63 x 1,5	NPT 2"	36 - 39	80	15	68	-	68	2	297.851.9	78,4
M63 x 1,5	NPT 2"	39 - 42	80	15	68	-	68	2	297.852.9	78,4
M63 x 1,5	NPT 2"	42 - 45	80	15	68	-	68	2	297.853.9	78,4

# ADAPTER IECEX-ATEX, RNC-316, IP66 / 68, STAINLESS STEEL

For unarmoured cable, IECEX-ATEX certified and marked;

 RCN (type) (threadsize) IECEX INE 10.0010X Ex d/e I Mb IIC Gb Ex tb IIIC Db  
 CE 0080 INERIS 06ATEX0014X I M2 / II 2 GD, IP66 / IP68 EAC

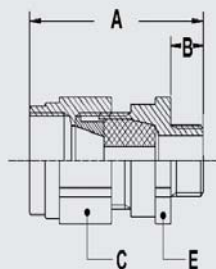

RNC-316, NPT, IECEX-ATEX cable-adapter, stainless steel

AISI-316, EPDM seal

(-40 °C till +100°C)



Thread	Thread	Clamping Range (mm)	Dimensions in mm					Standard Package	Article Number	Weight (Kg/100)
			A	B	C	D	E			
NPT 1/2"	NPT 1/2"	5,5 - 8	66	18	32	-	30	10	297.912.9	17,4
NPT 1/2"	NPT 1/2"	8 - 10,5	66	18	32	-	30	10	297.913.9	17,4
NPT 1/2"	NPT 1/2"	10,5 - 13	66	18	32	-	30	10	297.914.9	17,4
NPT 3/4"	NPT 3/4"	10,5 - 13	66	18	36	-	35	5	297.915.9	20,6
NPT 3/4"	NPT 3/4"	13 - 15,5	66	18	36	-	35	5	297.918.9	20,6
NPT 3/4"	NPT 3/4"	15,5 - 18	66	18	36	-	35	5	297.919.9	20,6
NPT 1"	NPT 1"	15 - 18	83	22	45	-	42	5	297.923.9	35,6
NPT 1"	NPT 1"	18 - 21	83	22	45	-	42	5	297.924.9	35,6
NPT 1"	NPT 1"	21 - 24	83	22	45	-	42	5	297.925.9	35,6
NPT 1.1/4"	NPT 1.1/4"	21 - 24	86	22	50	-	48	2	297.929.9	43,1
NPT 1.1/4"	NPT 1.1/4"	24 - 27	86	22	50	-	48	2	297.930.9	43,1
NPT 1.1/4"	NPT 1.1/4"	27 - 30	86	22	50	-	48	2	297.931.9	43,1
NPT 1.1/2"	NPT 1.1/2"	30 - 33	88	24	57	-	55	2	297.943.9	56,8
NPT 1.1/2"	NPT 1.1/2"	33 - 36	88	24	57	-	55	2	297.944.9	56,8
NPT 2"	NPT 2"	36 - 39	89	24	68	-	68	2	297.951.9	78,4
NPT 2"	NPT 2"	39 - 42	89	24	68	-	68	2	297.952.9	78,4
NPT 2"	NPT 2"	42 - 45	89	24	68	-	68	2	297.953.9	78,4
NPT 2.1/2"	NPT 2.1/2"	45 - 48	104	28	80	-	80	1	297.954.9	112,4
NPT 2.1/2"	NPT 2.1/2"	48 - 51	104	28	80	-	80	1	297.955.9	112,4
NPT 2.1/2"	NPT 2.1/2"	51 - 54	104	28	80	-	80	1	297.956.9	112,4
NPT 3"	NPT 3"	54 - 58	111	28	102	-	100	1	297.957.9	223,5
NPT 3"	NPT 3"	58 - 62	111	28	102	-	100	1	297.958.9	223,5

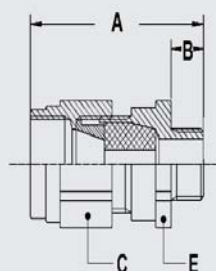

RNC-316, Pg, IECEX-ATEX cable-adapter, stainless steel

AISI-316, EPDM seal



(-40 °C till +100°C)



Thread	Thread	Clamping Range (mm)	Dimensions in mm					Standard Package	Article Number	Weight (Kg/100)
			A	B	C	D	E			
Pg 11	NPT 1/2"	5,5 - 8	63	15	32	-	30	10	297.611.9	17,4
Pg 13,5	NPT 1/2"	5,5 - 8	63	15	32	-	30	10	297.612.9	17,4
Pg 13,5	NPT 1/2"	8 - 10,5	63	15	32	-	30	10	297.613.9	17,4
Pg 13,5	NPT 1/2"	10,5 - 13	63	15	32	-	30	10	297.614.9	17,4
Pg 16	NPT 3/4"	10,5 - 13	63	15	36	-	35	5	297.615.9	20,6
Pg 16	NPT 3/4"	13 - 15,5	63	15	36	-	35	5	297.618.9	20,6
Pg 16	NPT 3/4"	15,5 - 18	63	15	36	-	35	5	297.619.9	20,6
Pg 21	NPT 1"	15 - 18	76	15	45	-	42	5	297.623.9	35,6
Pg 21	NPT 1"	18 - 21	76	15	45	-	42	5	297.624.9	35,6
Pg 21	NPT 1"	21 - 24	76	15	45	-	42	5	297.625.9	35,6
Pg 29	NPT 1.1/4"	21 - 24	81	17	50	-	48	2	297.629.9	43,1
Pg 29	NPT 1.1/4"	24 - 27	81	17	50	-	48	2	297.630.9	43,1
Pg 29	NPT 1.1/4"	27 - 30	81	17	50	-	48	2	297.631.9	43,1
Pg 36	NPT 1.1/2"	30 - 33	81	17	57	-	55	2	297.643.9	56,8
Pg 36	NPT 1.1/2"	33 - 36	81	17	57	-	55	2	297.644.9	56,8
Pg 48	NPT 2"	36 - 39	83	18	68	-	68	2	297.651.9	78,4
Pg 48	NPT 2"	39 - 42	83	18	68	-	68	2	297.652.9	78,4
Pg 48	NPT 2"	42 - 45	83	18	68	-	68	2	297.653.9	78,4

# ADAPTER IECEX-ATEX, RAC-316, IP66 / 68, STAINLESS STEEL

For armoured cable, IECEX-ATEX certified and marked;

 RCN (type) (threadsize) IECEX INE 10.0010X Ex d/e I Mb IIC Gb Ex tb IIIC Db  
  0080 INERIS 06ATEX0014X I M2 / II 2 GD, IP66 / IP68 **EAC**



RAC-316, ISO, IECEX-ATEX EMC cable-adapter, stainless steel  
 AISI-316, EPDM seal

**EAC**  **IECEX**  
 ATEX

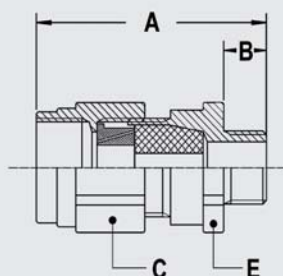

Thread	Thread	Clamping Range (mm)	Dimensions in mm					Standard Package	Article Number	Weight (Kg/100)
Outer ISO	Inner NPT		A	B	C	D	E			
M20 x 1,5	NPT 1/2"	5,5 - 8	63	15	32	-	30	10	839.812.9	17,4
M20 x 1,5	NPT 1/2"	8 - 10,5	63	15	32	-	30	10	839.813.9	17,4
M20 x 1,5	NPT 1/2"	10,5 - 13	63	15	32	-	30	10	839.814.9	17,4
M25 x 1,5	NPT 3/4"	10,5 - 13	63	15	36	-	35	5	839.815.9	20,6
M25 x 1,5	NPT 3/4"	13 - 15,5	63	15	36	-	35	5	839.818.9	20,6
M25 x 1,5	NPT 3/4"	15,5 - 18	63	15	36	-	35	5	839.819.9	20,6
M32 x 1,5	NPT 1"	15 - 18	76	15	45	-	42	5	839.823.9	35,6
M32 x 1,5	NPT 1"	18 - 21	76	15	45	-	42	5	839.824.9	35,6
M32 x 1,5	NPT 1"	21 - 24	76	15	45	-	42	5	839.825.9	35,6
M40 x 1,5	NPT 1.1/4"	21 - 24	79	15	50	-	48	2	839.829.9	43,1
M40 x 1,5	NPT 1.1/4"	24 - 27	79	15	50	-	48	2	839.830.9	43,1
M40 x 1,5	NPT 1.1/4"	27 - 30	79	15	50	-	48	2	839.831.9	43,1
M50 x 1,5	NPT 1.1/2"	30 - 33	79	15	57	-	55	2	839.843.9	56,8
M50 x 1,5	NPT 1.1/2"	33 - 36	79	15	57	-	55	2	839.844.9	56,8
M63 x 1,5	NPT 2"	36 - 39	80	15	68	-	68	2	839.851.9	78,4
M63 x 1,5	NPT 2"	39 - 42	80	15	68	-	68	2	839.852.9	78,4
M63 x 1,5	NPT 2"	42 - 45	80	15	68	-	68	2	839.853.9	78,4
M75 x 1,5	NPT 2.1/2"	45 - 48	91	15	80	-	80	1	839.854.9	112,4
M75 x 1,5	NPT 2.1/2"	48 - 51	91	15	80	-	80	1	839.855.9	112,4
M75 x 1,5	NPT 2.1/2"	51 - 54	91	15	80	-	80	1	839.856.9	112,4
M90 x 2	NPT 3"	54 - 58	103	20	102	-	100	1	839.857.9	223,5
M90 x 2	NPT 3"	58 - 62	103	20	102	-	100	1	839.858.9	223,5

## Special information for EMC cable-hose-fittings

1. In case of EMC versions, the cable diameter needed to determine the clamping range, is not the outside diameter of the cable but the diameter of the cable without the braiding.
2. In case of EMC versions with a wire diameter (S) from 1,0 till 2,5 mm (type SWA, Steel Wire Armour) a special 2 piece clamping ring (reduced cone) must be ordered.

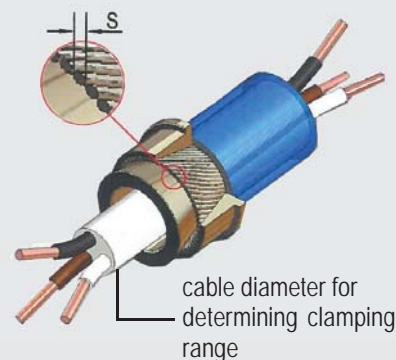



# ADAPTER IECEX-ATEX, RAC-316, IP66 / 68, STAINLESS STEEL

For armoured cable, IECEX-ATEX certified and marked;

RCN (type) (threadsize) IECEX INE 10.0010X Ex d/e I Mb IIC Gb Ex tb IIIC Db

CE 0080 INERIS 06ATEX0014X I M2 / II 2 GD, IP66 / IP68 EAC

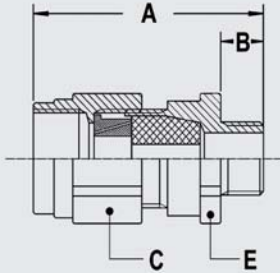

RAC-316, NPT, IECEX-ATEX EMC cable-adapter, stainless steel AISI-316, EPDM seal

(-40 °C till +100 °C)



Thread	Thread	Clamping Range (mm)	Dimensions in mm					Standard Package	Article Number	Weight (Kg/100)
			A	B	C	D	E			
NPT 1/2"	NPT 1/2"	5,5 - 8	66	18	32	-	30	10	839.912.9	17,4
NPT 1/2"	NPT 1/2"	8 - 10,5	66	18	32	-	30	10	839.913.9	17,4
NPT 1/2"	NPT 1/2"	10,5 - 13	66	18	32	-	30	10	839.914.9	17,4
NPT 3/4"	NPT 3/4"	10,5 - 13	66	18	36	-	35	5	839.915.9	20,6
NPT 3/4"	NPT 3/4"	13 - 15,5	66	18	36	-	35	5	839.918.9	20,6
NPT 3/4"	NPT 3/4"	15,5 - 18	66	18	36	-	35	5	839.919.9	20,6
NPT 1"	NPT 1"	15 - 18	83	22	45	-	42	5	839.923.9	35,6
NPT 1"	NPT 1"	18 - 21	83	22	45	-	42	5	839.924.9	35,6
NPT 1"	NPT 1"	21 - 24	83	22	45	-	42	5	839.925.9	35,6
NPT 1.1/4"	NPT 1.1/4"	21 - 24	86	22	50	-	48	2	839.929.9	43,1
NPT 1.1/4"	NPT 1.1/4"	24 - 27	86	22	50	-	48	2	839.930.9	43,1
NPT 1.1/4"	NPT 1.1/4"	27 - 30	86	22	50	-	48	2	839.931.9	43,1
NPT 1.1/2"	NPT 1.1/2"	30 - 33	88	24	57	-	55	2	839.943.9	56,8
NPT 1.1/2"	NPT 1.1/2"	33 - 36	88	24	57	-	55	2	839.944.9	56,8
NPT 2"	NPT 2"	36 - 39	89	24	68	-	68	2	839.951.9	78,4
NPT 2"	NPT 2"	39 - 42	89	24	68	-	68	2	839.952.9	78,4
NPT 2"	NPT 2"	42 - 45	89	24	68	-	68	2	839.953.9	78,4
NPT 2.1/2"	NPT 2.1/2"	45 - 48	104	28	80	-	80	1	839.954.9	112,4
NPT 2.1/2"	NPT 2.1/2"	48 - 51	104	28	80	-	80	1	839.955.9	112,4
NPT 2.1/2"	NPT 2.1/2"	51 - 54	104	28	80	-	80	1	839.956.9	112,4
NPT 3"	NPT 3"	54 - 58	111	28	102	-	100	1	839.957.9	223,5
NPT 3"	NPT 3"	58 - 62	111	28	102	-	100	1	839.958.9	223,5

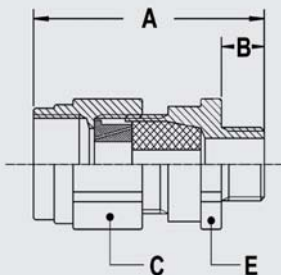

RAC-316, Pg, IECEX-ATEX EMC cable-adapter, stainless steel AISI-316, EPDM seal

(-40 °C till +100 °C)



Thread	Thread	Clamping Range (mm)	Dimensions in mm					Standard Package	Article Number	Weight (Kg/100)
			A	B	C	D	E			
Pg 11	NPT 1/2"	5,5 - 8	63	15	32	-	30	10	839.611.9	17,4
Pg 13,5	NPT 1/2"	5,5 - 8	63	15	32	-	30	10	839.612.9	17,4
Pg 13,5	NPT 1/2"	8 - 10,5	63	15	32	-	30	10	839.613.9	17,4
Pg 13,5	NPT 1/2"	10,5 - 13	63	15	32	-	30	10	839.614.9	17,4
Pg 16	NPT 3/4"	10,5 - 13	63	15	36	-	35	5	839.615.9	20,6
Pg 16	NPT 3/4"	13 - 15,5	63	15	36	-	35	5	839.618.9	20,6
Pg 16	NPT 3/4"	15,5 - 18	63	15	36	-	35	5	839.619.9	20,6
Pg 21	NPT 1"	15 - 18	76	15	45	-	42	5	839.623.9	35,6
Pg 21	NPT 1"	18 - 21	76	15	45	-	42	5	839.624.9	35,6
Pg 21	NPT 1"	21 - 24	76	15	45	-	42	5	839.625.9	35,6
Pg 29	NPT 1.1/4"	21 - 24	81	17	50	-	48	2	839.629.9	43,1
Pg 29	NPT 1.1/4"	24 - 27	81	17	50	-	48	2	839.630.9	43,1
Pg 29	NPT 1.1/4"	27 - 30	81	17	50	-	48	2	839.631.9	43,1
Pg 36	NPT 1.1/2"	30 - 33	81	17	57	-	55	2	839.643.9	56,8
Pg 36	NPT 1.1/2"	33 - 36	81	17	57	-	55	2	839.644.9	56,8
Pg 48	NPT 2"	36 - 39	83	18	68	-	68	2	839.651.9	78,4
Pg 48	NPT 2"	39 - 42	83	18	68	-	68	2	839.652.9	78,4
Pg 48	NPT 2"	42 - 45	83	18	68	-	68	2	839.653.9	78,4

# ADAPTER IECEx-ATEX, RNC-316, IP66 / 68, STAINLESS STEEL

Anaconda fittings, stainless steel AISI-316, for combination with adapter RNC-316 / RAC-316

The connection with an Anaconda conduit is made through a stainless steel male Anaconda swivel fitting 45° or 90° which is screwed into the female thread of the adapter. Because RNA-316 and RAA-316 cable hose fittings are available only till 1.1/4", if a solution for big sizes is needed, it is also possible to use the RNC-316 and RAA-316 adapter from 1.1/2" up to 3" size in combination with Anaconda stainless steel AISI-316 straight fittings.

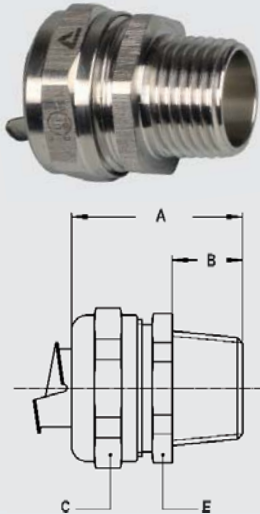

NPT straight fitting, compact, male, stainless steel AISI-316



Thread	Sealtite Size (NW)	Min. Internal Bore (mm)	Dimensions in mm					Standard Package	Article Number	Weight (Kg/100)
			A	B	C	D	E			
NPT 1/2"	3/8"	11,0	35	14	26	-	24	10	714.112.9	4,4
NPT 1/2"	1/2"	14,5	36	14	29	-	27	10	714.116.9	5,0
NPT 3/4"	3/4"	19,4	37	14	35	-	33	5	714.120.9	7,0
NPT 1"	1"	24,7	40	16	45	-	42	5	714.126.9	12,6
NPT 1.1/4"	1.1/4"	33,3	43	16	53	-	50	2	714.135.9	16,8
NPT 1.1/2"	1.1/2"	38,0	50	18	62	-	58	2	714.140.9	25,8
NPT 2"	2"	49,0	56	20	76	-	72	2	714.150.9	41,2
NPT 2.1/2"	2.1/2"	60,7	67	25	90	-	85	1	714.163.9*	83,6
NPT 3"	3"	75,5	73	27	108	-	102	1	714.175.9*	113,9

\* Size NPT 2.1/2" and NPT 3" are without UL/CSA.

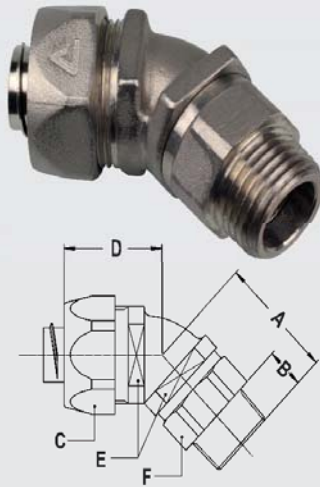

NPT 45° swivel fitting, male, stainless steel AISI-316



Thread	Sealtite Size (NW)	Min. Internal Bore (mm)	Dimensions in mm						Standard Package	Article Number	Weight (Kg/100)
			A	B	C	D	E	F			
NPT 1/2"	3/8"	10,4	36	12	27	28	22	22	10	819.212.9	11,5
NPT 1/2"	1/2"	13,8	36	12	30	30	27	25	10	819.216.9	14,0
NPT 3/4"	3/4"	17,4	47	14	36	37	33	33	5	838.220.9	22,0
NPT 1"	1"	23,4	54	15	46	46	42	42	5	838.226.9	37,0

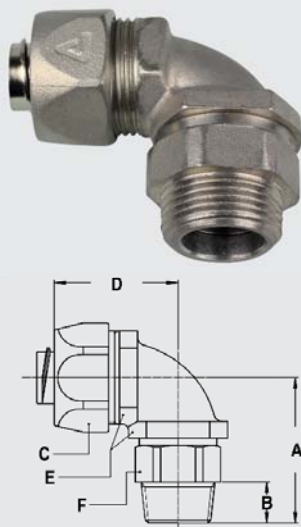

NPT 90° swivel fitting, male, stainless steel AISI-316



Thread	Sealtite Size (NW)	Min. Internal Bore (mm)	Dimensions in mm						Standard Package	Article Number	Weight (Kg/100)
			A	B	C	D	E	F			
NPT 1/2"	3/8"	10,4	41	12	27	35	22	22	10	819.512.9	12,0
NPT 1/2"	1/2"	13,8	41	12	30	37	27	25	10	819.516.9	14,0
NPT 3/4"	3/4"	17,4	60	14	36	50	33	33	5	838.520.9	23,5
NPT 1"	1"	23,4	102	15	46	60	42	42	5	838.526.9	42,0