

KZ 1000 V1

Compact Height

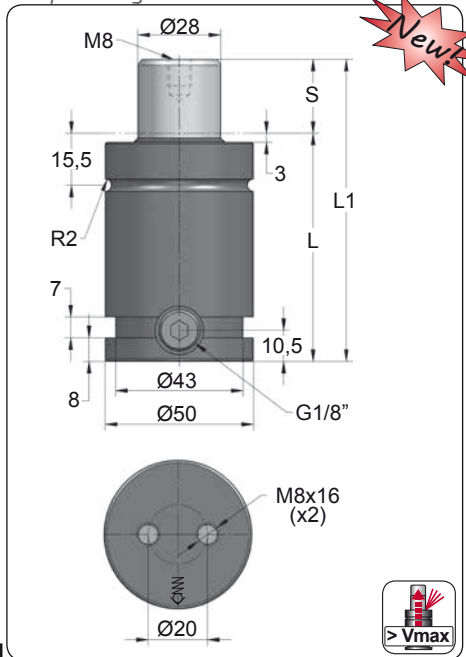

ORDER	S (mm)	L1 ±0.25 (mm)	L (mm)	Kg.
KZ 1000 013 V1	13	78	65	0.74
KZ 1000 016 V1	16	84	68	0.76
KZ 1000 019 V1	19	90	71	0.79
KZ 1000 025 V1	25	102	77	0.84
KZ 1000 032 V1	32	116	84	0.90
KZ 1000 038 V1	38	128	90	0.95
KZ 1000 050 V1	50	152	102	1.05
KZ 1000 063 V1	63	178	115	1.16
KZ 1000 075 V1	75	202	127	1.26
KZ 1000 080 V1	80	212	132	1.30
KZ 1000 100 V1	100	252	152	1.47
KZ 1000 125 V1	125	302	177	1.68

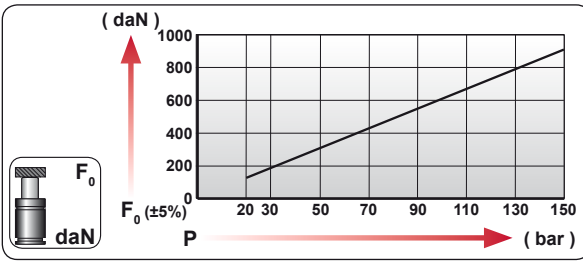

CODE	[Valve Icon]	Pressure		F ₀ daN	F ₁ daN
		bar	psi		
KZ 1000 050 V1	[Valve Icon]	150	2175	920	1495
KZ-H 1000 050 V1	[Valve Icon]	0	0	---	---

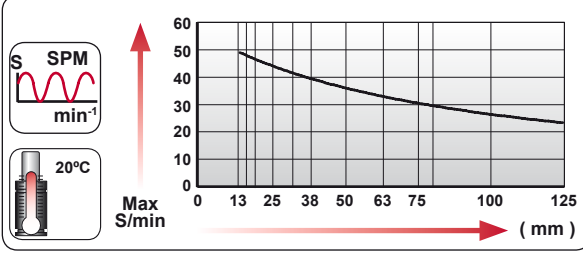
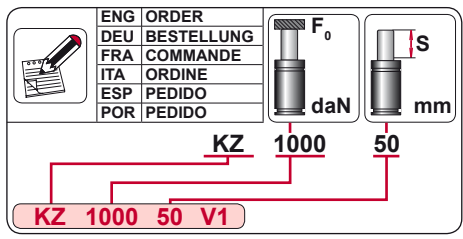
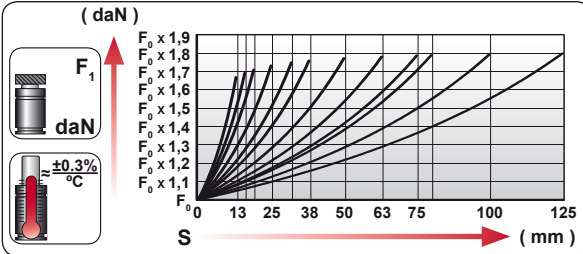

N₂

S_{max} < 90%

V_{max} 1,6 m/s

P_{min} (20°C)
P_{max} (20°C)

T_{min}
T_{max}

600 CP-

N ₂	S _{max} < 90%	V _{max} 1,6 m/s	bar psi 20 290	bar psi 150 2175	°C °F 0 32	°C °F 80 176	600 CP-
----------------	------------------------	--------------------------	-------------------	---------------------	---------------	-----------------	---------



KZ 1000 V1 MOUNTS

Compact Height

	L1=131 L1=138 L1=152	L1=138	L1=138 L1=150 L1=150	L1=170 L1=185 L1=195	L1=195	L1=165 L1=175	L1=220	
MODEL	X CR 1000 CW 1000 KZ 1000	AS 1000	CT 750 CK 1000 FD 750	GN 750 CM 1000 CD 1000	AG 750	CPH 1700 CP 2000	CS 1800	
SERIES	MINI 	COMPACT HEIGHT 	THREADED 	LOW PROFILE 	HEAVY DUTY 	ISO 	HEAVY LOAD 	POWER COMPACT STROKE

A14-050

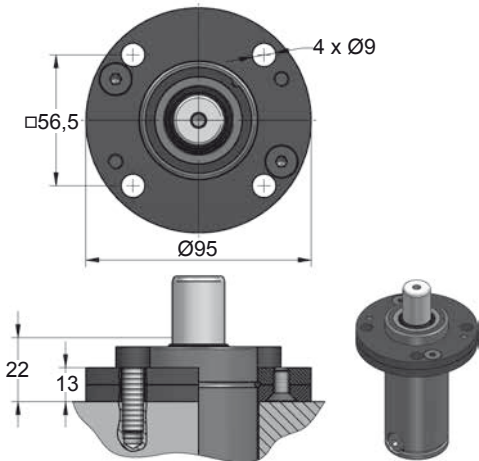

A34-050

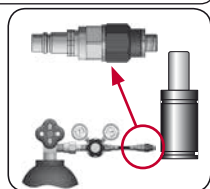
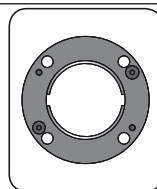
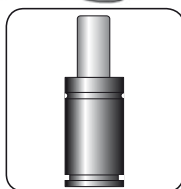
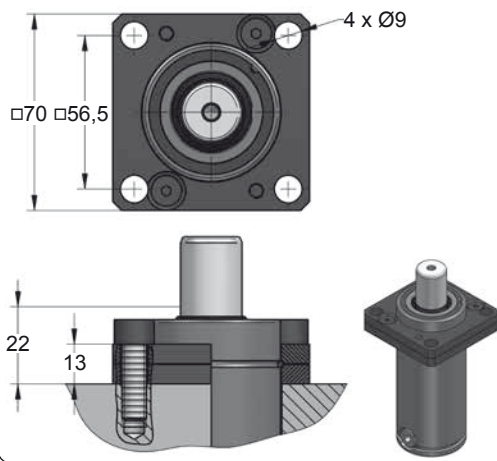

CODE	KZ 1000 050 V1	KIT S-XXXXXXX KIT C-XXXXXXX	A14-050	18 CG 1-Q
ENG ORDER	GAS SPRING	REPAIR KIT	FLANGE	CHARGING ADAPTER
DEU BESTELLUNG	GASDRUCKFEDER	ERSATZTEILSATZ	FLANSCHEN	LADEADAPTER
FRA COMMANDE	RESSORT À GAZ	KIT DE RÉPARATION	BRIDE	RACCORD DE CHARGE
ITA ORDINE	CILINDRO AD AZOTO	KIT DI MANUTENZIONE	FLANGE	ADATTATORE DI CARICO
ESP PEDIDO	RESORTE DE GAS	KIT DE REPARACION	BRIDA	ADAPTADOR DE CARGA
POR PEDIDO	CILINDRO DE GÁS	KIT DE MANUTENÇÃO	FLANGE	ADAPTADOR DE CARGA



KZ 1000 V1 MOUNTS

Compact Height

C05-050

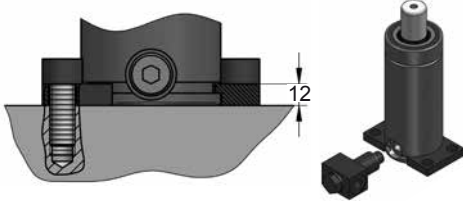
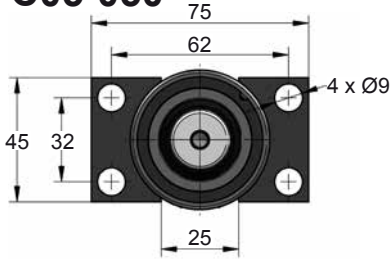

C20-050

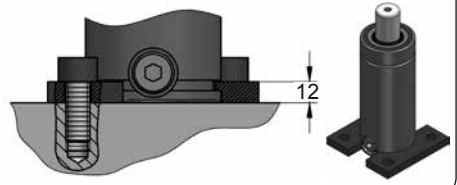
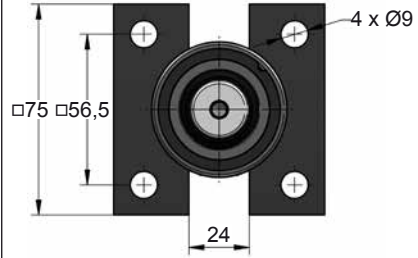

D02-050

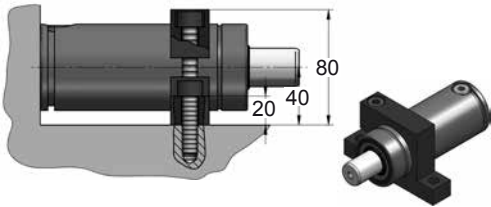
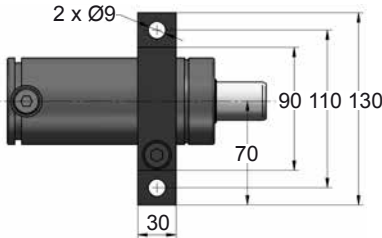

D82-050

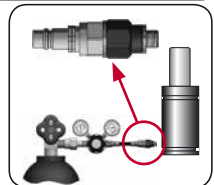
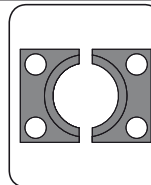
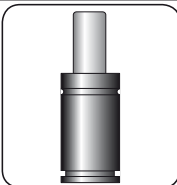
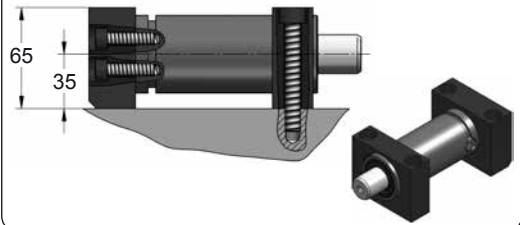
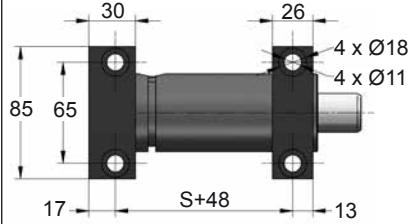

CODE	KZ 1000 050 V1	KIT S-XXXXXXX KIT C-XXXXXXX	C05-050	18 CG 1-Q
ENG	ORDER	GAS SPRING	FLANGE	CHARGING ADAPTER
DEU	BESTELLUNG	GASDRUCKFEDER	FLANSCH	LADEADAPTER
FRA	COMMANDE	RESSORT À GAZ	BRIDE	RACCORD DE CHARGE
ITA	ORDINE	CILINDRO AD AZOTO	FLANGE	ADATTATORE DI CARICO
ESP	PEDIDO	RESORTE DE GAS	BRIDA	ADAPTADOR DE CARGA
POR	PEDIDO	CILINDRO DE GÁS	FLANGE	ADAPTADOR DE CARGA