

CW 320 V1

Compact Height

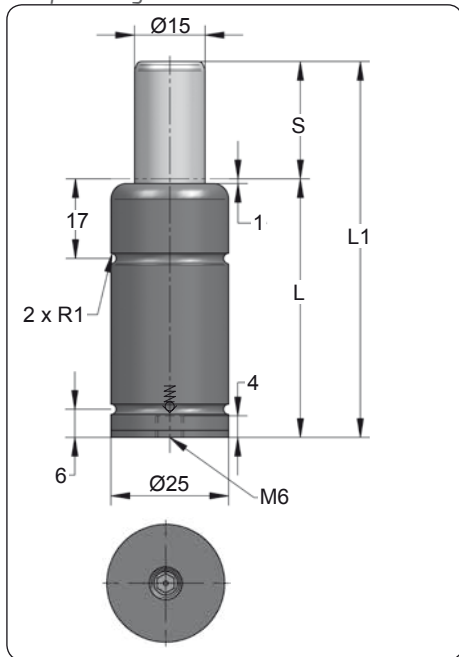

ORDER	S (mm)	L1 ±0,25 (mm)	L (mm)	Kg.
CW 320 007 V1	7	44	37	0.13
CW 320 010 V1	10	50	40	0.14
CW 320 012 V1	12	54	42	0.14
CW 320 015 V1	15	60	45	0.15
CW 320 019 V1	19	68	49	0.16
CW 320 025 V1	25	80	55	0.17
CW 320 032 V1	32	94	62	0.20
CW 320 038 V1	38	106	68	0.23
CW 320 050 V1	50	130	80	0.26
CW 320 063 V1	63	156	93	0.29
CW 320 075 V1	75	185	110	0.30
CW 320 080 V1	80	195	115	0.34
CW 320 100 V1	100	235	135	0.40
CW 320 125 V1	125	285	160	0.46

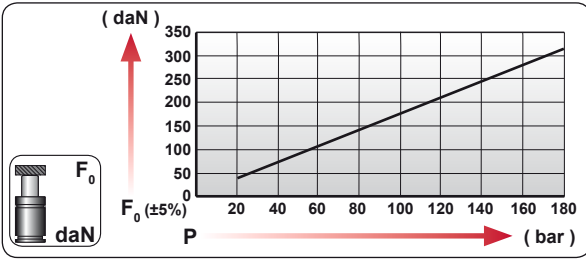

CODE			F_0 daN	F_1 daN
CW 320 050 V1		180 bar / 2610 psi	320	670
-----		-----	-----	-----

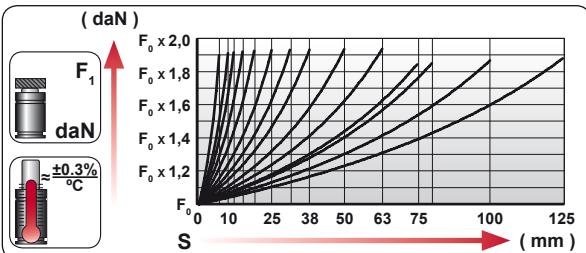

	ENG ORDER DEU BESTELLUNG FRA COMMANDE ITA ORDINE ESP PEDIDO POR PEDIDO	F_0 daN	S mm
		CW 320	50
		CW 320 050 V1	

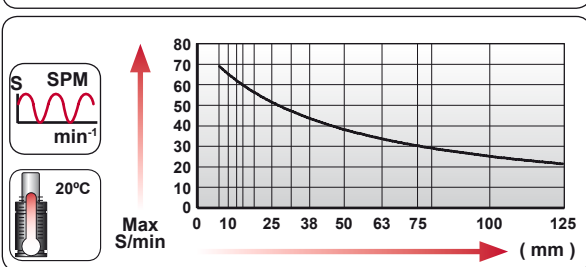

	$S_{max} < 100\%$	v					
N_2	$S_{max} < 90\%$	$v_{max} 1,6 \text{ m/s}$	$P_{min} (20^\circ C)$	$P_{max} (20^\circ C)$	T_{min}	T_{max}	

N_2	$S_{max} < 90\%$	$v_{max} 1,6 \text{ m/s}$	bar psi	bar psi	°C °F	°C °F	°C °F	
			20 290	180 2610	0 32	80 176		



CW 320 V1 MOUNTS

Compact Height

A44-025

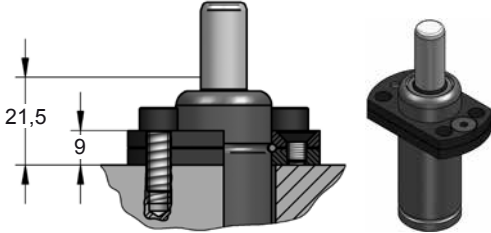
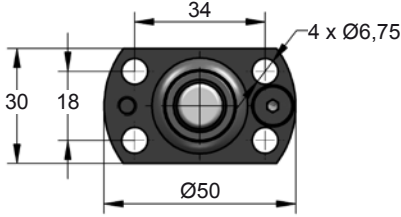

A49-025

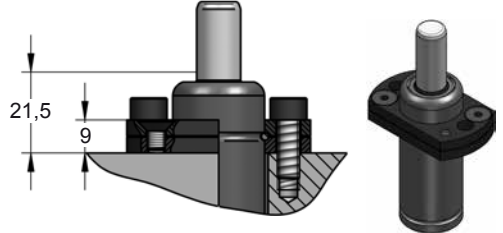
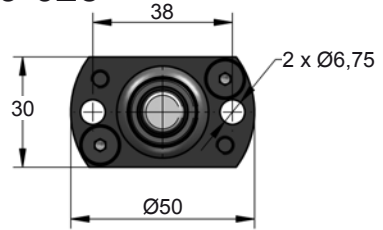

D02-025

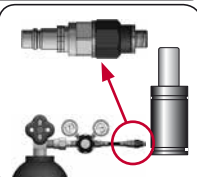
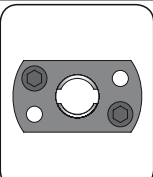
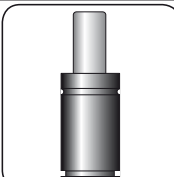
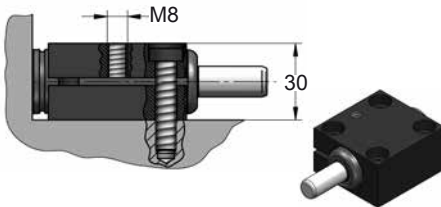
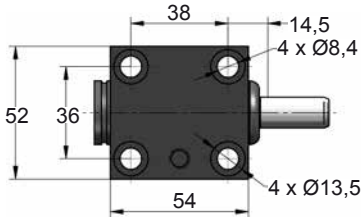

CODE	CW 320 050 V1	X	A44-025	06 CG 2-Q
ENG ORDER	GAS SPRING	REPAIR KIT	FLANGE	CHARGING ADAPTER
DEU BESTELLUNG	GASDRUCKFEDER	ERSATZTEILSATZ	FLANSCHEN	LADEADAPTER
FRA COMMANDE	RESSORT À GAZ	KIT DE RÉPARATION	BRIDE	RACCORD DE CHARGE
ITA ORDINE	CILINDRO AD AZOTO	KIT DI MANUTENZIONE	FLANGE	ADATTATORE DI CARICO
ESP PEDIDO	RESORTE DE GAS	KIT DE REPARACION	BRIDA	ADAPTADOR DE CARGA
POR PEDIDO	CILINDRO DE GÁS	KIT DE MANUTENÇÃO	FLANGE	ADAPTADOR DE CARGA