

# CS-KC 18300 V1

Power Compact Stroke

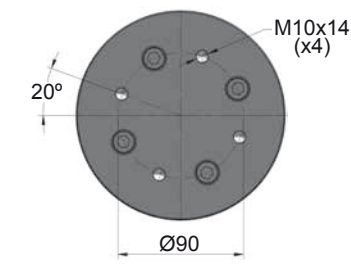

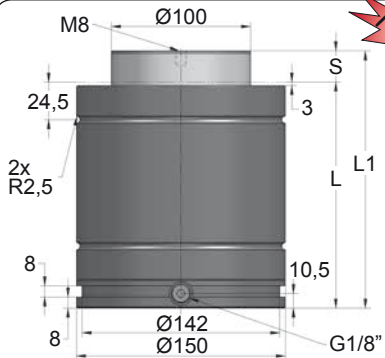

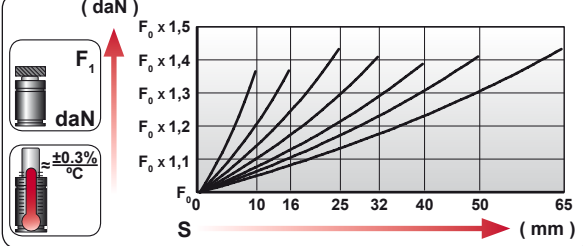
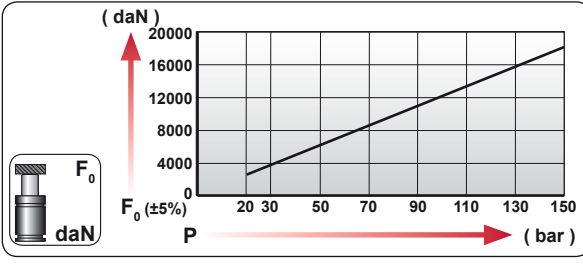

ORDER	S (mm)	L1 ±0,25 (mm)	L (mm)	Kg.
CS-KC 18300 010 V1	10	130	120	12.21
CS-KC 18300 016 V1	16	156	140	13.22
CS-KC 18300 025 V1	25	185	160	14.31
CS-KC 18300 032 V1	32	217	185	15.56
CS-KC 18300 040 V1	40	255	215	17.05
CS-KC 18300 050 V1	50	290	240	18.38
CS-KC 18300 065 V1	65	343	278	20.39

CODE				
		bar	psi	daN
-----		---	---	---
CS-KC 18300 050 V1		0	0	---

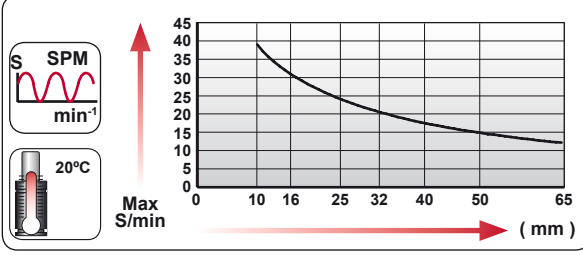

ENG ORDER	DEU BESTELLUNG	FRA COMMANDE	ITA ORDINE	ESP PEDIDO	POR PEDIDO
CS-KC 18300		50			
CS-KC 18300 050 V1					



N <sub>2</sub>	Smax < 90%	Vmax 0,5 m/s	Pmin (20°C)	Pmax (20°C)	Tmin Tmax	600 CP-

bar	psi	bar	psi	°C	°F	°C	°F	
20	290	150	2175	0	32	80	176	



# CS-KC 18300 V1 MOUNTS

Power Compact Stroke

	<h2>CS-KC</h2>	<h2>CS</h2>																																			
	<table border="1"> <thead> <tr> <th>CODE</th> <th></th> <th></th> <th></th> <th></th> </tr> <tr> <th></th> <th>bar</th> <th>psi</th> <th>daN</th> <th>daN</th> </tr> </thead> <tbody> <tr> <td>CS-KC 18300 050 V1</td> <td></td> <td>0</td> <td>0</td> <td>---</td> </tr> </tbody> </table>	CODE						bar	psi	daN	daN	CS-KC 18300 050 V1		0	0	---	<table border="1"> <thead> <tr> <th>CODE</th> <th></th> <th></th> <th></th> <th></th> </tr> <tr> <th></th> <th>bar</th> <th>psi</th> <th>daN</th> <th>daN</th> </tr> </thead> <tbody> <tr> <td>CS 18300 050 V1</td> <td></td> <td>150</td> <td>2175</td> <td>18410</td> </tr> <tr> <td></td> <td></td> <td></td> <td>26340</td> <td></td> </tr> </tbody> </table>	CODE						bar	psi	daN	daN	CS 18300 050 V1		150	2175	18410				26340	
CODE																																					
	bar	psi	daN	daN																																	
CS-KC 18300 050 V1		0	0	---																																	
CODE																																					
	bar	psi	daN	daN																																	
CS 18300 050 V1		150	2175	18410																																	
			26340																																		

## C20-150

## KC 18300

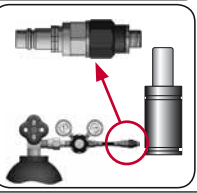
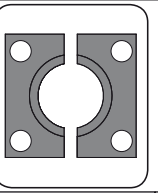

CODE	CS-KC 18300 050 V1	KIT S-XXXXXXX	C20-150	SKK 12R 1/8
ENG ORDER	GAS SPRING	REPAIR KIT	FLANGE	CHARGING ADAPTER
DEU BESTELLUNG	GASDRUCKFEDER	ERSATZTEILSATZ	FLANSCH	LADEADAPTER
FRA COMMANDE	RESSORT À GAZ	KIT DE RÉPARATION	BRIDE	RACCORD DE CHARGE
ITA ORDINE	CILINDRO AD AZOTO	KIT DI MANUTENZIONE	FLANGE	ADATTATORE DI CARICO
ESP PEDIDO	RESORTE DE GAS	KIT DE REPARACION	BRIDA	ADAPTADOR DE CARGA
POR PEDIDO	CILINDRO DE GÁS	KIT DE MANUTENÇÃO	FLANGE	ADAPTADOR DE CARGA