

BASIN TAP WA100-1



Ø 52 x 171 x 185 mm

Normal pressure

- Single-lever basin tap without waste fitting in robust, germ-reducing and easy-care stainless steel (AISI 303).
- Version: normal pressure. Operating pressure 2–6 bar.
- Solid stainless steel body; visible surfaces satin finished. Further available surfaces: see below.
- High quality ceramic mixer cartridge with adjustable temperature limit setting (scald protection).
- Neoperl® air bubble spray M21 x 1 mm.
- Design height: 171 mm
Outlet height: 87 mm
Projection: 98 mm
Length of lever: 140 mm
- Wear parts can be replaced as modules.
- Installation dimensions: Ø 33-40 mm
Surface thickness max. 40 mm
- Mounting: With one counternut.
- Delivery includes fixing material and two flexible connecting hoses clad in stainless steel.
- Weight, including single package: 1.4 kg



Suggested text for specifications:

Single-lever basin tap in stainless steel (AISI 303) for counter mounting. Version: normal pressure. Solid stainless steel body; visible surfaces satin finished. Ceramic mixer cartridge with adjustable temperature limit setting. Delivery includes fixing material and two flexible connecting hoses clad in stainless steel.

Dimensions: Ø 52 x 171 x 185 mm

Outlet height 87 mm

Projection 98 mm

Length of lever 140 mm

Article No. WA100-1

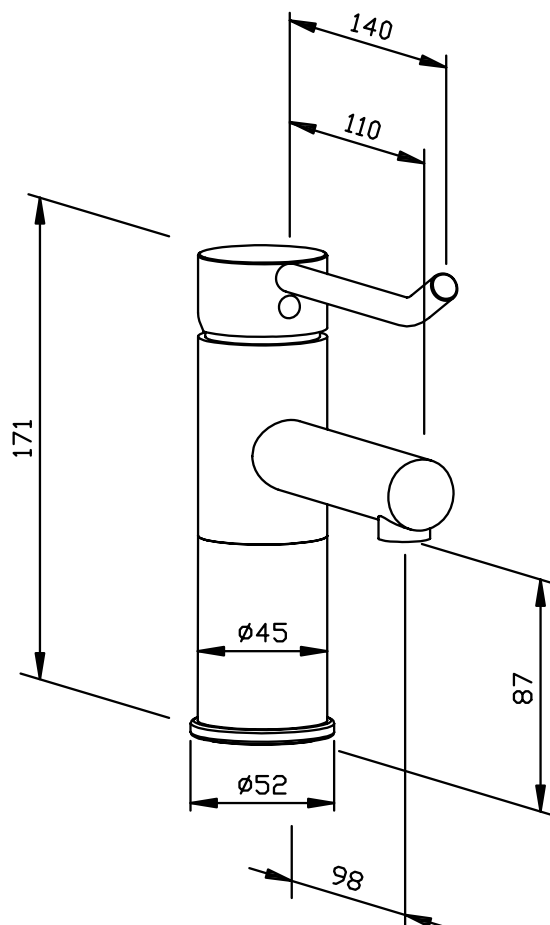

Available surfaces

ID No.

satin finished (standard)

924 276

highly polished

931 276

Ernst Wagner GmbH & Co. KG

Ernst-Abbe-Straße 21 · D-72770 Reutlingen · Tel.: +49712151539-0 · Fax: -20
info@wagner-ewar.de · www.wagner-ewar.de

WAGNER
EWAR