

# MOLLA TONDA, DI GOMMA 70 SHORE A

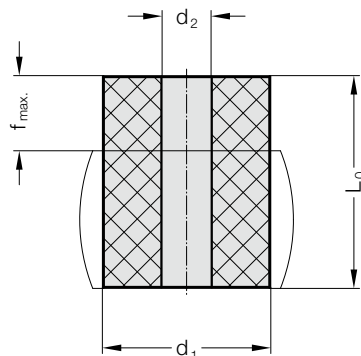

2461.2.



## Materiale:

Caucciù di cloroprene 70 Shore A  
Colore: nero

## Nota:

A causa delle loro caratteristiche fisiche, le molle in elastomero hanno una certa tendenza alla deformazione. Quest'ultima dipende dal calore di attrito interno, velocità cambio carico, numero, freccia e durezza shore.  
E può essere pari al 3-5 % della freccia  $L_0$ .

## Caratteristiche fisiche:

Resistenza alla trazione secondo DIN 53504:  
 $\geq 12 \text{ N/mm}^2$   
Allungamento a rottura secondo DIN 53504:  $\geq 250 \%$   
Peso specifico secondo DIN 53479:  $1.37 \text{ g/cm}^3$   
Deformazione residua alla compressione secondo DIN 53517:  $\leq 20 \%$  (24 h/70 °C)  
Range di temperatura di utilizzo: -20 °C fino a 80 °C breve fino a 120 °C

## 2461.2. Molla tonda, di gomma 70 Shore A

N. d'ordine	$d_1$	$L_0$	$d_2$	f max.	N. d'ordine	$d_1$	$L_0$	$d_2$	f max.
2461.2.016.012	16	12	6,5	4,8	2461.2.063.100	63	100	17	40
2461.2.016.016	16	16	6,5	6,4	2461.2.063.125	63	125	17	50
2461.2.016.020	16	20	6,5	8	2461.2.080.032	80	32	21	12,8
2461.2.016.025	16	25	6,5	10	2461.2.080.040	80	40	21	16
2461.2.020.016	20	16	8,5	6,4	2461.2.080.050	80	50	21	20
2461.2.020.020	20	20	8,5	8	2461.2.080.063	80	63	21	25,2
2461.2.020.025	20	25	8,5	10	2461.2.080.080	80	80	21	32
2461.2.020.032	20	32	8,5	12,8	2461.2.080.100	80	100	21	40
2461.2.025.020	25	20	10,5	8	2461.2.080.125	80	125	21	50
2461.2.025.025	25	25	10,5	10	2461.2.100.032	100	32	21	12,8
2461.2.025.032	25	32	10,5	12,8	2461.2.100.040	100	40	21	16
2461.2.025.040	25	40	10,5	16	2461.2.100.050	100	50	21	20
2461.2.032.032	32	32	13,5	12,8	2461.2.100.063	100	63	21	25,2
2461.2.032.040	32	40	13,5	16	2461.2.100.080	100	80	21	32
2461.2.032.050	32	50	13,5	20	2461.2.100.100	100	100	21	40
2461.2.032.063	32	63	13,5	25,2	2461.2.100.125	100	125	21	50
2461.2.040.032	40	32	13,5	12,8	2461.2.125.032	125	32	27	12,8
2461.2.040.040	40	40	13,5	16	2461.2.125.040	125	40	27	16
2461.2.040.050	40	50	13,5	20	2461.2.125.050	125	50	27	20
2461.2.040.063	40	63	13,5	25,2	2461.2.125.063	125	63	27	25,2
2461.2.040.080	40	80	13,5	32	2461.2.125.080	125	80	27	32
2461.2.050.032	50	32	17	12,8	2461.2.125.100	125	100	27	40
2461.2.050.040	50	40	17	16	2461.2.125.125	125	125	27	50
2461.2.050.050	50	50	17	20	2461.2.125.160	125	160	27	64
2461.2.050.063	50	63	17	25,2					
2461.2.050.080	50	80	17	32					
2461.2.050.100	50	100	17	40					
2461.2.063.032	63	32	17	12,8					
2461.2.063.040	63	40	17	16					
2461.2.063.050	63	50	17	20					
2461.2.063.063	63	63	17	25,2					
2461.2.063.080	63	80	17	32					

2461.2.016.

Ø 16/70 Shore A

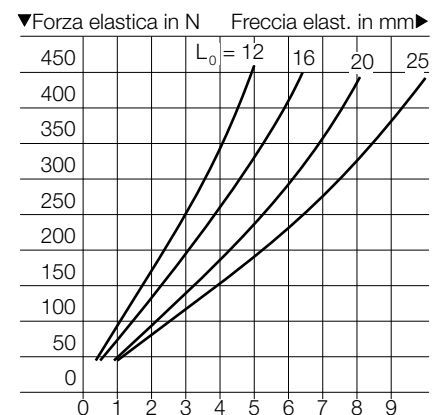



# MOLLA TONDA, DI GOMMA 70 SHORE A

**2461.2.020.**  
Ø 20/70 Shore A

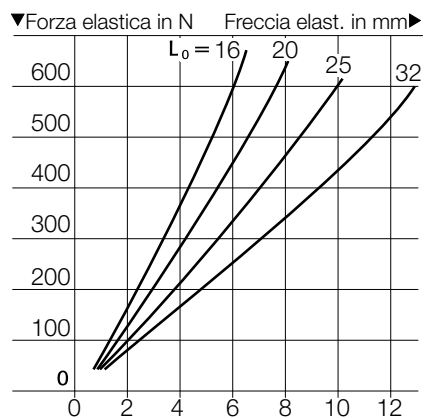

**2461.2.025.**  
Ø 25/70 Shore A

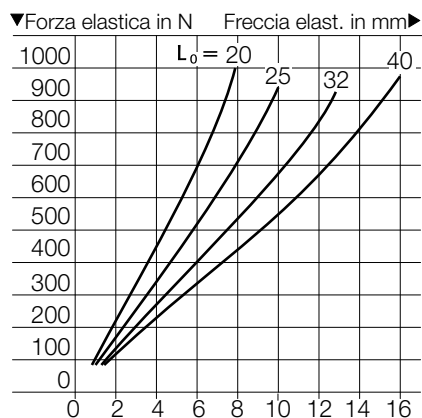

**2461.2.032.**  
Ø 32/70 Shore A

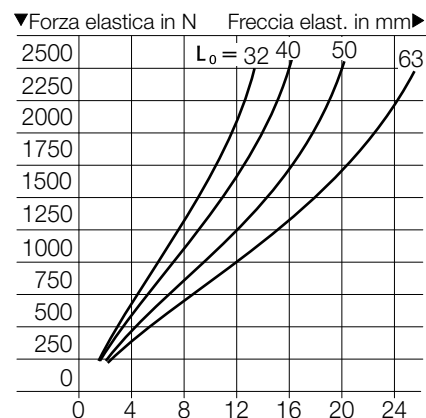

**2461.2.040.**  
Ø 40/70 Shore A

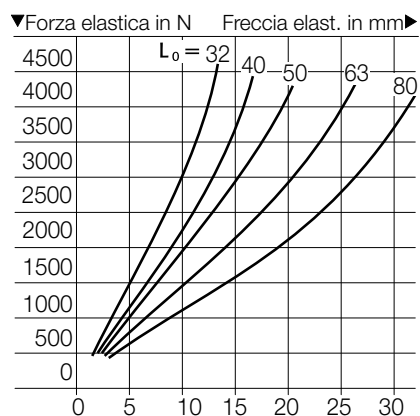

**2461.2.050.**  
Ø 50/70 Shore A

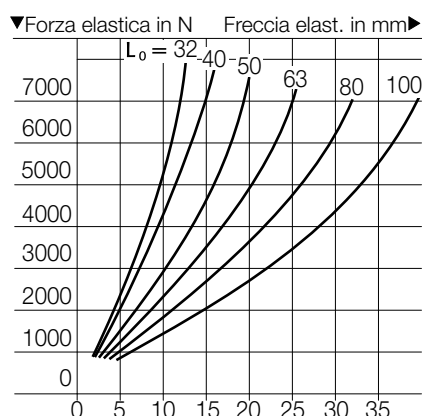

**2461.2.063.**  
Ø 63/70 Shore A

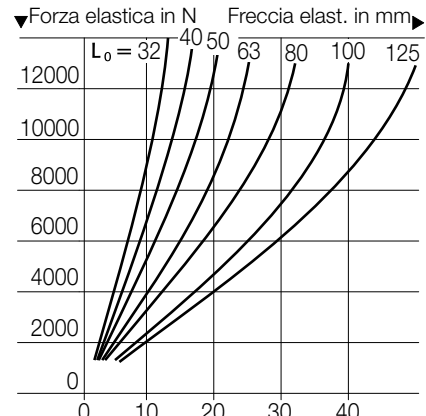

**2461.2.080.**  
Ø 80/70 Shore A

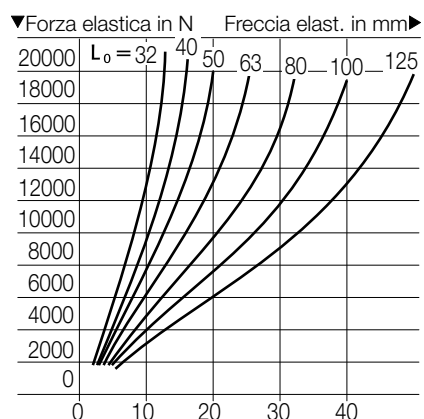

**2461.2.100.**  
Ø 100/70 Shore A

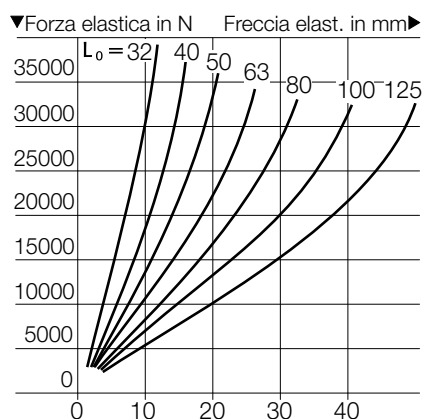

**2461.2.125.**  
Ø 125/70 Shore A

