

Stainless steel-high pressure filter

Pi 480

Nominal pressure 450/250 bar (6425/3570 psi), nominal size 40 up to 250

1. Features

High performance filters for modern hydraulic systems

- Modular system
- Compact design
- Minimal pressure drop through optimal flow design
- Visual/electrical/electronic maintenance indicator
- Threaded connections
- Quality filters, easy to service
- Equipped with highly efficient glass fibre PS filter elements according to DIN 24550
- Beta rated elements according to ISO 16889 multipass test
- Elements with high differential pressure stability and dirt holding capacity
- NPT- and SAE-connections on request
- Worldwide distribution



2. Flow rate/pressure drop curve complete filter

■ 190 mm²/s
 ■ 33 mm²/s

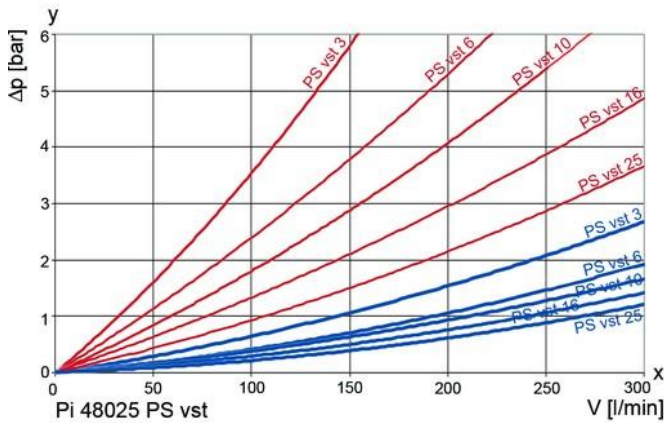
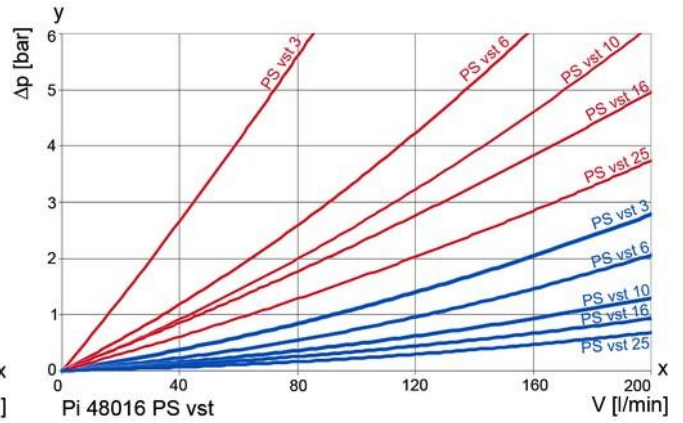
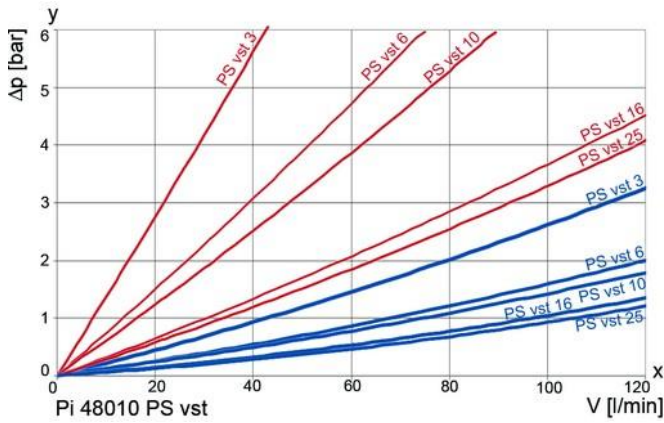
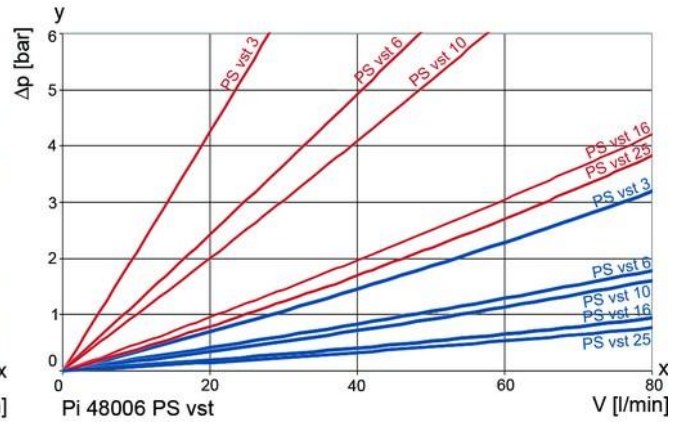
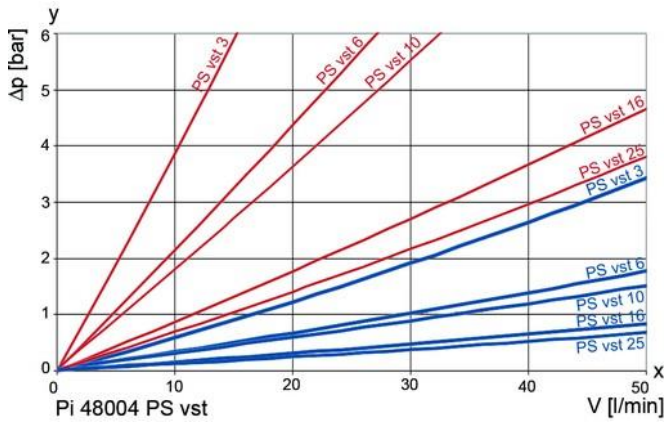

y = differential pressure Δp [bar]
 x = flow rate V [l/min]

3. Separation grade characteristics

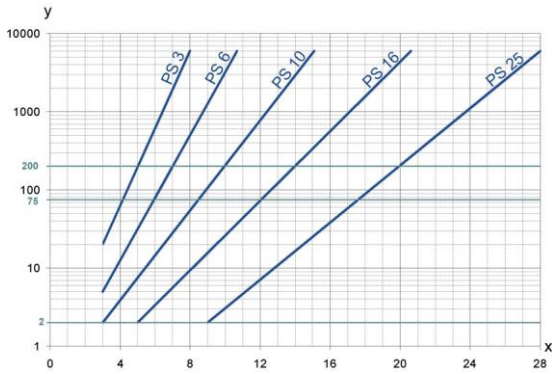

y = beta-value
x = particle size [μm]

determined by multipass tests (ISO 16889)
calibration according to ISO 11171 (NIST)

4. Filter performance data

tested according to ISO 16889 (multipass test)

PS vst elements with
max. Δp 210 bar

PS vst	3	$\beta_{5(C)}$	≥ 200
PS vst	6	$\beta_{7(C)}$	≥ 200
PS vst	10	$\beta_{10(C)}$	≥ 200
PS vst	16	$\beta_{15(C)}$	≥ 200
PS vst	25	$\beta_{20(C)}$	≥ 200

values guaranteed up to 20 bar
differential pressure

5. Quality assurance

Filtration Group filters and filter elements are produced according to the following international standards:

Norm	Designation
DIN ISO 2941	Hydraulic fluid power filter elements; verification of collapse/burst resistance
DIN ISO 2942	Hydraulic fluid power filter elements; verification of fabrication integrity
DIN ISO 2943	Hydraulic fluid power filter elements; verification of material compatibility with fluids
DIN ISO 3723	Hydraulic fluid power filter elements; method for end load test
DIN ISO 3724	Hydraulic fluid power filter elements; verification of flow fatigue characteristics
ISO 3968	Hydraulic fluid power-filters-evaluation of pressure drop versus flow characteristics
ISO 10771.1	Fatigue pressure testing of metal containing envelopes in hydraulic fluid applications
ISO 16889	Hydraulic fluid power filters-multi-passmethod for evaluation filtration performance of a filter element

6. Symbols

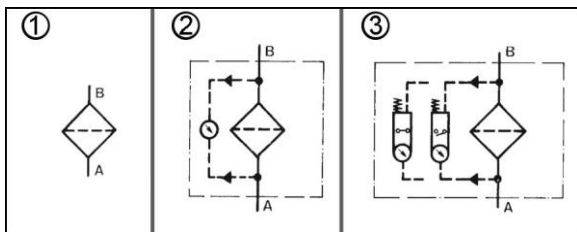

7. Order numbers

Example for ordering filters:

1. Filter housing	2. Filter element
V = 100 l/min and electrical maintenance indicator Type: Pi 48010-015 Order number: 79324583	PS vst 6 Type: Pi 71010 DN PS vst 6 Order number: 77960131

7.1 Housing design					
Nominal size NG [l/min]	Order number	Type	① no options	② with visual indicator	③ with electrical indicator
40	78397556	Pi 48004-060			
	78306607	Pi 48004-014			
	79343351	Pi 48004-015			
63	79762295	Pi 48006-060			
	79702325	Pi 48006-014			
	70368277	Pi 48006-015			
100	78308660	Pi 48010-060			
	79353236	Pi 48010-014			
	79324583	Pi 48010-015			
160	70368297	Pi 48016-060			
	70368298	Pi 48016-014			
	79353160	Pi 48016-015			
250	70368299	Pi 48025-060			
	70368302	Pi 48025-014			
	76109284	Pi 48025-015			

7.2 Filter elements*

Nominal size NG [l/min]	Order number	Type	Filter material	max. Δp [bar]	Filter surface [cm ²]
40	78216079	Pi 71004 DN PS vst 3	PS vst 3	210	445
	77960156	Pi 72004 DN PS vst 6	PS vst 6		445
	77925654	Pi 73004 DN PS vst 10	PS vst 10		445
	78216087	Pi 74004 DN PS vst 16	PS vst 16		445
	78216095	Pi 75004 DN PS vst 25	PS vst 25		445
63	78216137	Pi 71006 DN PS vst 3	PS vst 3	210	780
	77960149	Pi 72006 DN PS vst 6	PS vst 6		780
	77925662	Pi 73006 DN PS vst 10	PS vst 10		780
	78216145	Pi 74006 DN PS vst 16	PS vst 16		780
	78216152	Pi 75006 DN PS vst 25	PS vst 25		780
100	78227480	Pi 71010 DN PS vst 3	PS vst 3	210	1275
	77960131	Pi 72010 DN PS vst 6	PS vst 6		1275
	77925670	Pi 73010 DN PS vst 10	PS vst 10		1275
	78261281	Pi 74010 DN PS vst 16	PS vst 16		1275
	78216160	Pi 75010 DN PS vst 25	PS vst 25		1275
160	77940638	Pi 71016 DN PS vst 3	PS vst 3	210	1885
	77960123	Pi 72016 DN PS vst 6	PS vst 6		1885
	77925688	Pi 73016 DN PS vst 10	PS vst 10		1885
	78269797	Pi 74016 DN PS vst 16	PS vst 16		1885
	78216178	Pi 75016 DN PS vst 25	PS vst 25		1885
250	77940646	Pi 71025 DN PS vst 3	PS vst 3	210	3090
	77960115	Pi 72025 DN PS vst 6	PS vst 6		3090
	77925696	Pi 73025 DN PS vst 10	PS vst 10		3090
	78269813	Pi 74025 DN PS vst 16	PS vst 16		3090
	78216186	Pi 75025 DN PS vst 25	PS vst 25		3090

*a wider range of element types is available on request

8. Technical specifications

Design:	in-line filter
Nominal pressure:	2x 10 ⁶ load changes 450 bar (6425 psi)
NG 40 up to 100	250 bar (3570 psi)
NG 160 and 250	700 bar (10000 psi)
Test pressure:	325 bar (4640 psi)
NG 40 up to 100	
NG 160 and 250	
Connections:	
NG 40 up to 100	G1
NG 160 and 250	G1½
Temperature range:	-10 °C to +120 °C (other temperature ranges on request)
Filter head and housing material:	TP 316/TP 316 L (1.4401/1.4404) (other materials on request)
Sealing material:	NBR/PTFE
Maintenance indicator setting:	Δ p 5 bar ± 10 %
Electrical data of maintenance indicator:	
Maximum voltage:	250 V AC/200 V DC
Maximum current:	1 A
Contact load:	70 W IP 65 in inserted and secured status
Type of protection:	normally open/closed
Contact:	
Cable sleeve:	M20x1.5

The switching function can be changed by turning the electric upper part by 180° (normally closed contact or normally open contact). The state on delivery is a normally closed contact. By inductivity in the direct current circuit the use of suitable protection circuit should be considered. Further maintenance indicator details and designs are available in the maintenance indicator data sheet.

We draw attention to the fact that all values indicated are average values and not not always occur in specific cases of application. Our products are continually being further developed. Values, dimensions and weights can change as a result of this. Our specialized department will be pleased to offer you advice.

We recommend to contact us concerning applications of our filters in areas governed by the EU Directive 94/9 EG (ATEX 95). The standard version can be used for liquids based on mineral oil (corresponding to the fluids in Group 2 of Directive 97/23 EG Article 9). If you consider to use other fluids please contact us for additional support.

Subject to technical alteration without prior notice.

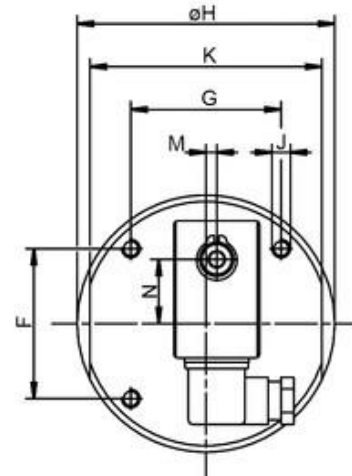
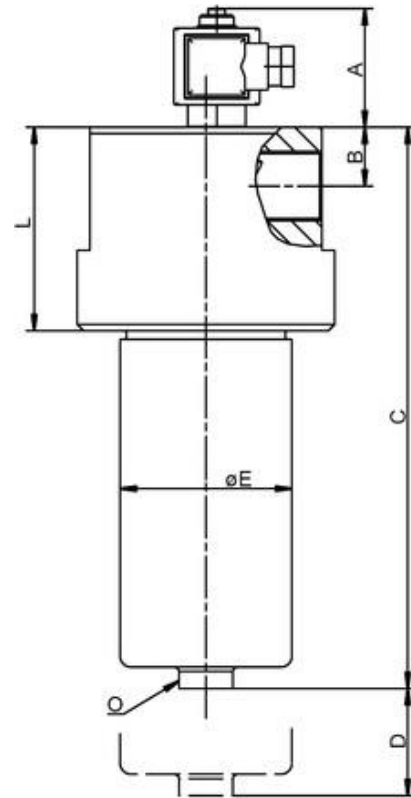

9. Dimensions

All dimensions in mm.

Type	A	B	C ± 5	D	E	F	G	H	J	K	L	M	N	O (SW)
Pi 48004	60	27.5	202	100	80	70	70	120	M8	108	95	5	30.0	30
Pi 48006	60	27.5	262	100	80	70	70	120	M8	108	95	5	30.0	30
Pi 48010	60	27.5	352	100	80	70	70	120	M8	108	95	5	30.0	30
Pi 48016	60	42.0	310	130	120	78	78	150	M10	135	145	-	35.5	36
Pi 48025	60	42.0	400	130	120	78	78	150	M10	135	145	-	35.5	36

10. Installation, operating and maintenance instructions

10.1 Filter installation

When installing the filter make sure that sufficient space is available to remove filter element and filter housing!. Preferably the filter should be installed with the filter housing pointing downwards. The maintenance indicator must be visible.

10.2 Connecting the electrical maintenance indicator

The electrical indicator is connected via a 2-pole appliance plug according to DIN EN 175301-803 with poles marked 1 and 2. The electrical section can be inverted to change from normally open position to normally closed position or vice versa.

10.3 When should the filter element be replaced?

- Filters equipped with visual and electrical maintenance indicator:
During cold starts, the indicator may give a warning signal. Press the red button of the visual indicator once again only after operating temperature has been reached. If the red button immediately pops up again and/or the electrical signal has not switched off after reaching operating temperature, the filter element must be replaced after the end of the shift.
- Filters without maintenance indicator:
The filter element should be replaced after the trial run or flushing of the system. Afterwards follow instructions of the manufacturer.
- Please always ensure that you have original Filtration Group spare elements in stock: Disposable elements (PS) cannot be cleaned.

10.4 Element replacement

- Stop system and relieve filter from pressure.
- Unscrew the filter housing by turning counter-clockwise. Clean the housing using a suitable cleaning solvent.
- Remove element by pulling down carefully.
- Check o-ring and spigot for damage. Replace, if necessary.
- Make sure that the order number on the spare element corresponds to the order number of the filter name-plate. To ensure no contamination occurs during the exchange of the element first open the plastic bag and push the element over the spigot in the filter head. Now remove plastic bag.
- Lightly lubricate the threads of the filter housing a little bit and screw into the filter head. Maximum tightening torque for NG 50 to 110 = 60 Nm, for NG 150 to 450 = 100 Nm.

11. Spare parts list

Order numbers for spare parts		
Position	Type	Order number
①	Seal kit	
	Pi 48004 - 48010	
	NBR	79767443
	FPM	70315096
	EPDM	70303334
	Pi 48016 - 48025	
	NBR	70315097
	FPM	70315098
	EPDM	70368303
②	Maintenance indicator	
	Visual PiS 3193	78308538
	Electrical PiS 3192	78308546
	Electrical upper section only	77536550
③	Seal kit for maintenance indicator	
	NBR	77760275
	FPM	77760283
	EPDM	77760291

Filtration Group GmbH
Schleifbachweg 45
D-74613 Öhringen
Phone +49 7941 6466-0
Fax +49 7941 6466-429
industrial.sales@filtrationgroup.com
industrial.filtrationgroup.com
79323668.03/2021
[Stainless steel-high pressure filter Pi 480 NG 40 up to 250](#)