

Medium Pressure Filter

Pi 3000

Nominal pressure 200/315 bar (2900/4570 psi), nominal size up to 400
according to DIN 24550

1. Features

High performance filters for modern hydraulic systems

- Provided for pipe installation
- Modular system
- Compact design
- Minimal pressure drop through optimal flow design
- Visual/electrical/electronic maintenance indicator
- Threaded connections
- Quality filters, easy to service
- Equipped with highly efficient glass fibre PS filter elements
- Beta rated elements according to ISO 16889
- Elements with high differential pressure stability and dirt holding capacity
- NPT- and SAE-connections on request
- Worldwide distribution



2. Flow rate/pressure drop curve (filter housing incl. element)

■ 190 mm²/s
■ 33 mm²/s

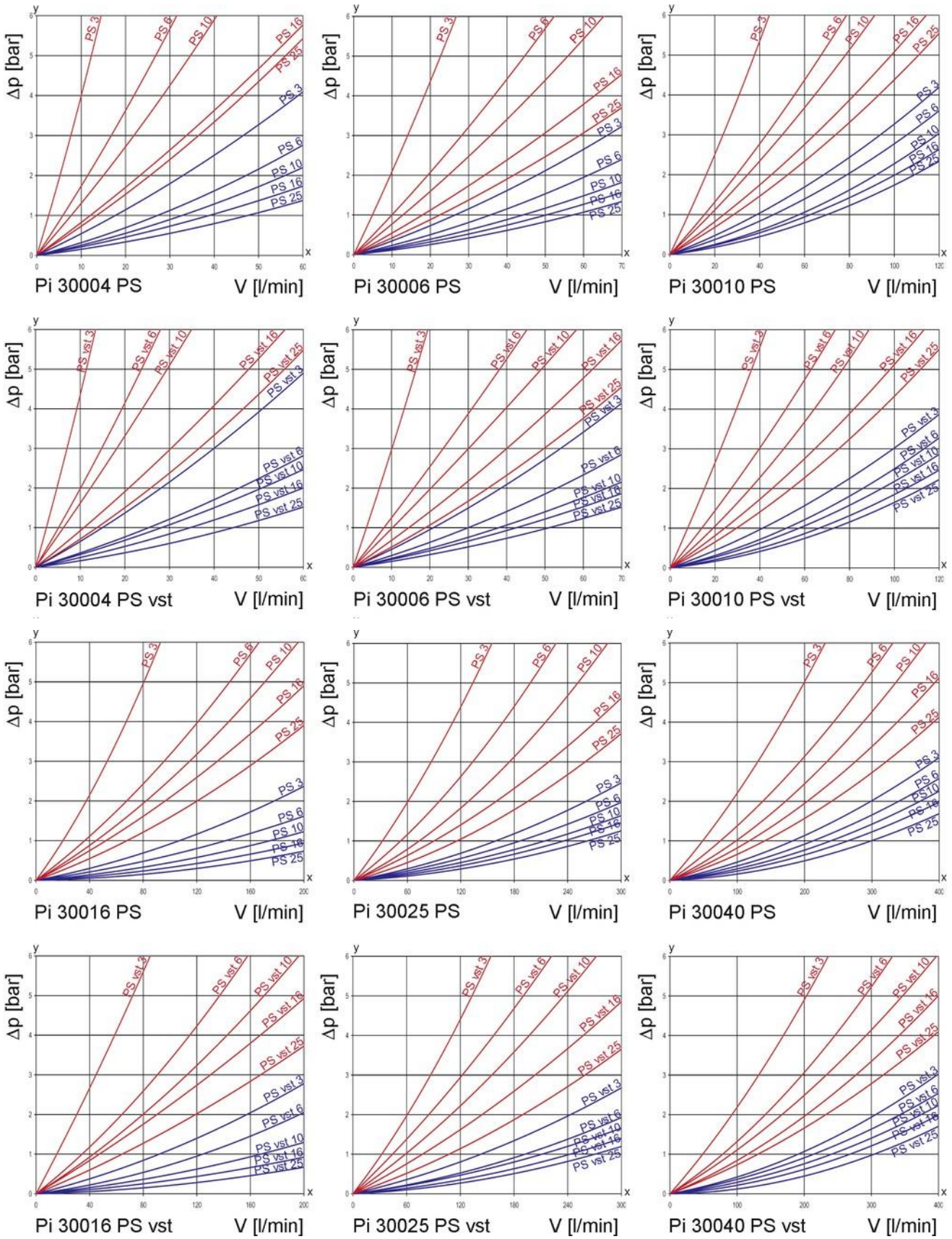

y = differential pressure Δp [bar]
 x = flow rate V [l/min]

3. Separation grade characteristics

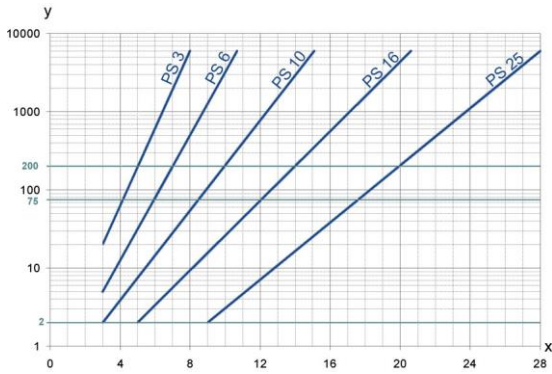

y = beta-value
x = particle size [μm]

determined by multipass tests (ISO 16889)
calibration according to ISO 11171 (NIST)

4. Filter performance data

tested according to ISO 16889 (multipass test)

PS elements with
max. Δp 20 bar

| | | |
|----|----|--------------------------|
| PS | 3 | $\beta_{5(C)} \geq 200$ |
| PS | 6 | $\beta_{7(C)} \geq 200$ |
| PS | 10 | $\beta_{10(C)} \geq 200$ |
| PS | 16 | $\beta_{15(C)} \geq 200$ |
| PS | 25 | $\beta_{20(C)} \geq 200$ |

values guaranteed up to
10 bar differential pressure

PS vst elements with
max. Δp 210 bar

| | | |
|--------|----|--------------------------|
| PS vst | 3 | $\beta_{5(C)} \geq 200$ |
| PS vst | 6 | $\beta_{7(C)} \geq 200$ |
| PS vst | 10 | $\beta_{10(C)} \geq 200$ |
| PS vst | 16 | $\beta_{15(C)} \geq 200$ |
| PS vst | 25 | $\beta_{20(C)} \geq 200$ |

values guaranteed up to
20 bar differential pressure

5. Quality assurance

Filtration Group filters and filter elements are produced according to the following international standards:

| Norm | Designation |
|--------------|---|
| DIN ISO 2941 | Hydraulic fluid power filter elements; verification of collapse/burst resistance |
| DIN ISO 2942 | Hydraulic fluid power filter elements; verification of fabrication integrity |
| DIN ISO 2943 | Hydraulic fluid power filter elements; verification of material compatibility with fluids |
| DIN ISO 3723 | Hydraulic fluid power filter elements; method for end load test |
| DIN ISO 3724 | Hydraulic fluid power filter elements; verification of flow fatigue characteristics |
| ISO 3968 | Hydraulic fluid power filters; evaluation of pressure drop versus flow characteristics |
| ISO 10771.1 | Fatigue pressure testing of metal containing envelopes in hydraulic fluid applications |
| ISO 16889 | Hydraulic fluid power filters; multipass method for evaluation filtration performance of a filter element |

6. Symbols

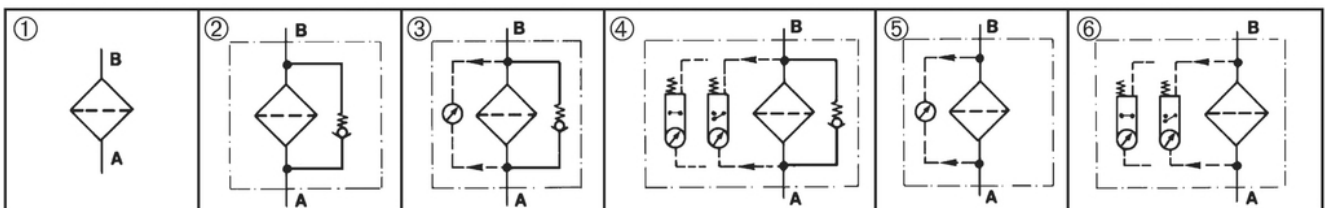

7. Order numbers

Example for ordering filters:

| 1. Filter housing | 2. Filter element |
|---|--|
| V = 100l/min and electrical maintenance indicator Type: Pi 30010-015 Order number: 78208084 | PS vst 3 Type: Pi 71010 DN PS vst 3 Order number: 78227480 |

| Nominal size NG [l/min] | Order number | Type | ① | ② | ③ | ④ | ⑤ | ⑥ |
|----------------------------|-----------------|--------------|-----------------------------|--|--|--|-----------------------------|---------------------------------|
| | | | with indicator cavity | with bypass valve and indicator cavity | with bypass valve and visual indicator | with bypass valve and electrical indicator | with visual indicator | with electrical indicator |
| 40 | 78207896 | Pi 30004-010 | | | | | | |
| | 78207904 | Pi 30004-011 | | | | | | |
| | 78337388 | Pi 30004-012 | | | | | | |
| | 78304206 | Pi 30004-013 | | | | | | |
| | 78207938 | Pi 30004-014 | | | | | | |
| | 78207946 | Pi 30004-015 | | | | | | |
| 63 | 78207961 | Pi 30006-010 | | | | | | |
| | 78207979 | Pi 30006-011 | | | | | | |
| | 78207987 | Pi 30006-012 | | | | | | |
| | 78304214 | Pi 30006-013 | | | | | | |
| | 78208001 | Pi 30006-014 | | | | | | |
| | 78208019 | Pi 30006-015 | | | | | | |
| 100 | 78208035 | Pi 30010-010 | | | | | | |
| | 78208043 | Pi 30010-011 | | | | | | |
| | 78208050 | Pi 30010-012 | | | | | | |
| | 78304222 | Pi 30010-013 | | | | | | |
| | 78208076 | Pi 30010-014 | | | | | | |
| | 78208084 | Pi 30010-015 | | | | | | |
| 160 | 78208100 | Pi 30016-010 | | | | | | |
| | 78208118 | Pi 30016-011 | | | | | | |
| | 78208126 | Pi 30016-012 | | | | | | |
| | 78259970 | Pi 30016-013 | | | | | | |
| | 78208142 | Pi 30016-014 | | | | | | |
| | 78208159 | Pi 30016-015 | | | | | | |
| 250 | 78208167 | Pi 30025-010 | | | | | | |
| | 78208175 | Pi 30025-011 | | | | | | |
| | 78208183 | Pi 30025-012 | | | | | | |
| | 78259988 | Pi 30025-013 | | | | | | |
| | 78208209 | Pi 30025-014 | | | | | | |
| | 78208217 | Pi 30025-015 | | | | | | |
| 400 | 78208225 | Pi 30040-010 | | | | | | |
| | 78208233 | Pi 30040-011 | | | | | | |
| | 78208241 | Pi 30040-012 | | | | | | |
| | 78259996 | Pi 30040-013 | | | | | | |
| | 78208266 | Pi 30040-014 | | | | | | |
| | 78208274 | Pi 30040-015 | | | | | | |

When filter with non bypass configuration is selected, the collapse pressure of the element must not be exceeded.

7.2 Filter elements*

| Nominal size NG [l/min] | Order number | Type | Filter material | max. Δp [bar] | Filter surface [cm ²] |
|----------------------------|--------------|---------------------------|-----------------|--------------------------|---|
| 40 | 78260929 | Pi 21004 DN PS 3 NBR | PS 3 | 20 | 475 |
| | 77960859 | Pi 22004 DN PS 6 NBR | PS 6 | | 475 |
| | 77925571 | Pi 23004 DN PS 10 NBR | PS 10 | | 475 |
| | 78260937 | Pi 24004 DN PS 16 NBR | PS 16 | | 475 |
| | 78260945 | Pi 25004 DN PS 25 NBR | PS 25 | | 475 |
| | 78216079 | Pi 71004 DN PS vst 3 NBR | PS vst 3 | 210 | 445 |
| | 77960156 | Pi 72004 DN PS vst 6 NBR | PS vst 6 | | 445 |
| | 77925654 | Pi 73004 DN PS vst 10 NBR | PS vst 10 | | 445 |
| | 78216087 | Pi 74004 DN PS vst 16 NBR | PS vst 16 | | 445 |
| | 78216095 | Pi 75004 DN PS vst 25 NBR | PS vst 25 | | 445 |
| 63 | 78260960 | Pi 21006 DN PS 3 NBR | PS 3 | 20 | 835 |
| | 77960867 | Pi 22006 DN PS 6 NBR | PS 6 | | 835 |
| | 77925589 | Pi 23006 DN PS 10 NBR | PS 10 | | 835 |
| | 78260978 | Pi 24006 DN PS 16 NBR | PS 16 | | 835 |
| | 78260986 | Pi 25006 DN PS 25 NBR | PS 25 | | 835 |
| | 78216137 | Pi 71006 DN PS vst 3 NBR | PS vst 3 | 210 | 780 |
| | 77960149 | Pi 72006 DN PS vst 6 NBR | PS vst 6 | | 780 |
| | 77925662 | Pi 73006 DN PS vst 10 NBR | PS vst 10 | | 780 |
| | 78216145 | Pi 74006 DN PS vst 16 NBR | PS vst 16 | | 780 |
| | 78216152 | Pi 75006 DN PS vst 25 NBR | PS vst 25 | | 780 |
| 100 | 78227472 | Pi 21010 DN PS 3 NBR | PS 3 | 20 | 1375 |
| | 77960875 | Pi 22010 DN PS 6 NBR | PS 6 | | 1375 |
| | 77925597 | Pi 23010 DN PS 10 NBR | PS 10 | | 1375 |
| | 78261000 | Pi 24010 DN PS 16 NBR | PS 16 | | 1375 |
| | 78261018 | Pi 25010 DN PS 25 NBR | PS 25 | | 1375 |
| | 78227480 | Pi 71010 DN PS vst 3 NBR | PS vst 3 | 210 | 1275 |
| | 77960131 | Pi 72010 DN PS vst 6 NBR | PS vst 6 | | 1275 |
| | 77925670 | Pi 73010 DN PS vst 10 NBR | PS vst 10 | | 1275 |
| | 78261281 | Pi 74010 DN PS vst 16 NBR | PS vst 16 | | 1275 |
| | 78216160 | Pi 75010 DN PS vst 25 NBR | PS vst 25 | | 1275 |

* a wider range of element types is available on request

7.2 Filter elements*

| Nominal size NG [l/min] | Order number | Type | Filter material | max. Δp [bar] | Filter surface [cm ²] |
|----------------------------|--------------|---------------------------|-----------------|--------------------------|---|
| 160 | 78261034 | Pi 21016 DN PS 3 NBR | PS 3 | 20 | 2530 |
| | 77960826 | Pi 22016 DN PS 6 NBR | PS 6 | | 2530 |
| | 77925605 | Pi 23016 DN PS 10 NBR | PS 10 | | 2530 |
| | 78261042 | Pi 24016 DN PS 16 NBR | PS 16 | | 2530 |
| | 78261059 | Pi 25016 DN PS 25 NBR | PS 25 | | 2530 |
| | 77940638 | Pi 71016 DN PS vst 3 NBR | PS vst 3 | 210 | 1885 |
| | 77960123 | Pi 72016 DN PS vst 6 NBR | PS vst 6 | | 1885 |
| | 77925688 | Pi 73016 DN PS vst 10 NBR | PS vst 10 | | 1885 |
| | 78269797 | Pi 74016 DN PS vst 16 NBR | PS vst 16 | | 1885 |
| | 78216178 | Pi 75016 DN PS vst 25 NBR | PS vst 25 | | 1885 |
| 250 | 78227514 | Pi 21025 DN PS 3 NBR | PS 3 | 20 | 4020 |
| | 77960834 | Pi 22025 DN PS 6 NBR | PS 6 | | 4020 |
| | 77925613 | Pi 23025 DN PS 10 NBR | PS 10 | | 4020 |
| | 78261075 | Pi 24025 DN PS 16 NBR | PS 16 | | 4020 |
| | 78261083 | Pi 25025 DN PS 25 NBR | PS 25 | | 4020 |
| | 77940646 | Pi 71025 DN PS vst 3 NBR | PS vst 3 | 210 | 3090 |
| | 77960115 | Pi 72025 DN PS vst 6 NBR | PS vst 6 | | 3090 |
| | 77925696 | Pi 73025 DN PS vst 10 NBR | PS vst 10 | | 3090 |
| | 78269813 | Pi 74025 DN PS vst 16 NBR | PS vst 16 | | 3090 |
| | 78216186 | Pi 75025 DN PS vst 25 NBR | PS vst 25 | | 3090 |
| 400 | 78227522 | Pi 21040 DN PS 3 NBR | PS 3 | 20 | 6770 |
| | 77960842 | Pi 22040 DN PS 6 NBR | PS 6 | | 6770 |
| | 77925621 | Pi 23040 DN PS 10 NBR | PS 10 | | 6770 |
| | 78261109 | Pi 24040 DN PS 16 NBR | PS 16 | | 6770 |
| | 78261117 | Pi 25040 DN PS 25 NBR | PS 25 | | 6770 |
| | 77940653 | Pi 71040 DN PS vst 3 NBR | PS vst 3 | 210 | 5240 |
| | 77960107 | Pi 72040 DN PS vst 6 NBR | PS vst 6 | | 5240 |
| | 77930829 | Pi 73040 DN PS vst 10 NBR | PS vst 10 | | 5240 |
| | 78269821 | Pi 74040 DN PS vst 16 NBR | PS vst 16 | | 5240 |
| | 78260903 | Pi 75040 DN PS vst 25 NBR | PS vst 25 | | 5240 |

* a wider range of element types is available on request

8. Technical specifications

| | |
|---|---------------------------------------|
| Design: | in-line filter |
| Nominal pressure: | |
| Pi 30004 - 30010 | 315 bar (4570 psi) |
| Pi 30016 - 30040 | 200 bar (2900 psi) |
| Test pressure: | |
| Pi 30004 - 30010 | 410 bar (5940 psi) |
| Pi 30016 - 30040 | 260 bar (3770 psi) |
| Temperature range: | -10 °C to +120 °C |
| | (other temperature ranges on request) |
| Bypass setting: | Δp 7 bar \pm 10 % |
| Filter head material: | GGG |
| Filter housing material: | St |
| Sealing material: | NBR/PTFE |
| Maintenance indicator setting: | Δp 5 bar \pm 10 % |
| Electrical data of maintenance indicator: | |
| Maximum voltage: | 250 V AC/200 V DC |
| Maximum current: | 1 A |
| Contact load: | 70 W |
| Type of protection: | IP 65 in inserted and secured status |
| Contact: | normally open/closed |
| Cable sleeve: | M20x1.5 |

The switching function can be changed by turning the electric upper part by 180° (normally closed contact or normally open contact). The state on delivery is a normally closed contact. By inductivity in the direct current circuit the use of suitable protection circuit should be considered. Further maintenance indicator details and designs are available in the maintenance indicator data sheet.

We draw attention to the fact that all values indicated are average values which do not always occur in specific cases of application. Our products are continually being further developed. Values, dimensions and weights can change as a result of this. Our specialized department will be pleased to offer you advice.

We recommend you to contact us concerning applications of our filters in areas governed by the EU Directive 94/9 EC (ATEX 95). The standard version can be used for liquids based on mineral oil (corresponding to the fluids in Group 2 of Directive 97/23 EC Article 9). If you consider to use other fluids please contact us for additional support.

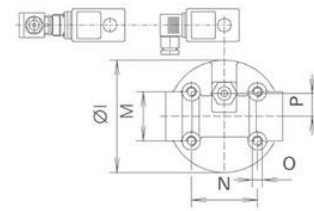
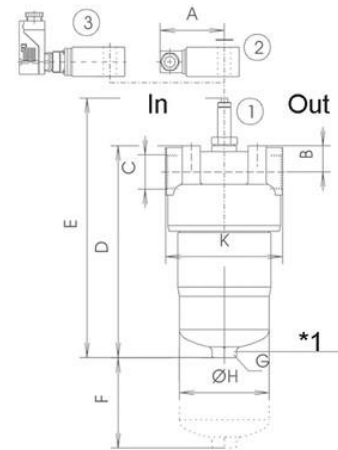

NG 160 - 400

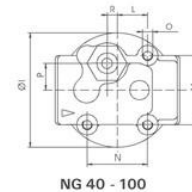

NG 40 - 100

In = inlet

Out = outlet

*1 NG 250, 400 with drain screw G ¼ DIN 910

- Pos. 1 Visual maintenance indicator
- Pos. 2 Electrical upper section connector according DIN EN 175301-803
Version: PiS 3092, 3105, 3115
- Pos. 3 Electrical upper section connector according DIN EN 175301-804
Version: PiS 3102, 3122, 3132

Subject to technical alteration without prior notice.

9. Dimensions

All dimensions except "C" in mm.

| Type | A | B | C* | D | E | F | G SW | H | I | K | L | M | N | O | P | R | Weight [kg] |
|----------|----|----|-----|-----|-----|-----|---------|-----|-----|-----|------|----|----|--------|----|---|----------------|
| Pi 30004 | 78 | 31 | G½ | 181 | 238 | 80 | 27 | 66 | 90 | 92 | 23.5 | 54 | 47 | M8x16 | 21 | 8 | 4.2 |
| Pi 30006 | 78 | 31 | G¾ | 241 | 298 | 80 | 27 | 66 | 90 | 92 | 23.5 | 54 | 47 | M8x16 | 21 | 8 | 4.9 |
| Pi 30010 | 78 | 31 | G1 | 331 | 389 | 80 | 27 | 66 | 90 | 92 | 23.5 | 54 | 47 | M8x16 | 21 | 8 | 5.8 |
| Pi 30016 | 78 | 32 | G1¼ | 267 | 324 | 110 | 30 | 109 | 137 | 142 | - | 60 | 80 | M12x16 | 28 | - | 10.0 |
| Pi 30025 | 78 | 32 | G1¼ | 357 | 414 | 110 | 30 | 109 | 137 | 142 | - | 60 | 80 | M12x16 | 28 | - | 12.0 |
| Pi 30040 | 78 | 32 | G1¼ | 507 | 564 | 110 | 30 | 109 | 137 | 142 | - | 60 | 80 | M12x16 | 28 | - | 15.6 |

* NPT- and SAE- port connections on request

10. Installation, operating and maintenance instructions

10.1 Filter installation

When installing the filter make sure that sufficient space is available to remove filter element and filter housing! Preferably the filter should be installed with the filter housing pointing downwards.

The maintenance indicator must be visible.

10.2 Connecting the electrical maintenance indicator

The electrical indicator is connected via a 2-pole appliance plug according to DIN EN 175301-803 with poles marked 1 and 2.

The electrical section can be inverted to change from normally open position to normally closed position or vice versa.

10.3 When should the filter element be replaced?

- Filters equipped with visual and electrical maintenance indicator:
During cold starts, the indicator may give a warning signal. Press the red button of the visual indicator once again only after operating temperature has been reached. If the red button immediately pops up again and/or the electrical signal has not switched off after reaching operating temperature, the filter element must be replaced after the end of the shift.
- Filters without maintenance indicator:
The filter element should be replaced after the trial run or flushing of the system. Afterwards follow instructions of the manufacturer.
- Please always ensure that you have Original Filtration Group spare elements in stock: Disposable elements (PS) cannot be cleaned.

10.4 Element replacement

- Stop system and relieve filter from pressure.
- Filter sizes 250 and 400: empty the filter housing by removing the drain plug.
- Unscrew the filter housing by turning counter-clockwise. Clean the housing using a suitable cleaning solvent.
- Remove element by pulling down carefully.
- Check o-ring and spigot for damage. Replace, if necessary.
- Make sure that the order number on the spare element corresponds to the order number of the filter name-plate. To ensure no contamination occurs during the exchange of the element first open the plastic bag and push the element over the spigot in the filter head. Now remove plastic bag.
- Lightly lubricate threads of the filter housing a little bit and screw into the filter head. Maximum tightening torque for NG 40 to 100 = 60 Nm, for NG 160 to 400 = 100 Nm.
- Check seals of vent drain plug - if necessary, please replace. Torque drain plug 30 Nm.

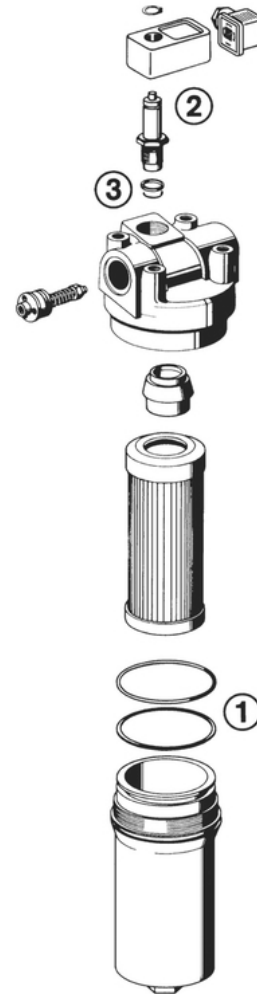

11. Spare parts list

| Order numbers for spare parts | | |
|-------------------------------|------------------------------------|--------------|
| Position | Type | Order number |
| ① | Seal kit for filter | |
| | Pi 30004 - Pi 30010 | |
| | NBR | 78383747 |
| | FPM | 78383754 |
| | EPDM | 78383762 |
| | Pi 30016 - Pi 30040 | |
| | NBR | 78383770 |
| | FPM | 78383788 |
| | EPDM | 78383796 |
| ② | Maintenance indicator | |
| | Visual PiS 3093/5 | 77669914 |
| | Electrical PiS 3092/5 | 77669864 |
| | Electrical upper section only | 77536550 |
| ③ | Seal kit for maintenance indicator | |
| | NBR | 77760275 |
| | FPM | 77760283 |
| | EPDM | 77760291 |

Filtration Group GmbH
Schleifbachweg 45
D-74613 Öhringen
Phone +49 7941 6466-0
Fax +49 7941 6466-429
industrial.sales@filtrationgroup.com
industrial.filtrationgroup.com
78396012.03/2021