

EWUM

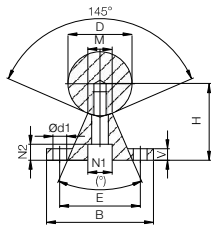

EWUMN

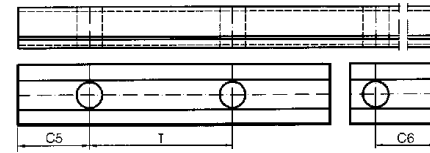
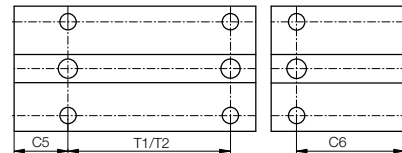
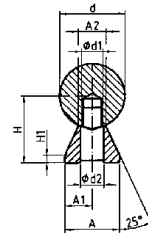

Abmessungen [mm] – unterstützte Edelstahlwellen 1.4125

Art.-Nr.	D	B	H	V	N1	N2	d1	M	E	T1 ⁸⁷⁾	C5/C6		T2	C5/C6		Gewicht	
											min.	max.		min.	max.		
	±0,02				±0,15						für T1	Standard	Standard			[kg/m]	
EWUM-12	12	40	22	5	8,0	5,0	4,5	5,8	50	29	75	20	57	120	20	79	1,75
EWUM-16	16	45	26	5	9,5	6,0	5,5	7,0	50	33	100	20	69	150	20	94	2,64
EWUM-20	20	52	32	6	11,0	6,5	6,6	8,3	50	37	100	20	69	150	20	94	3,97
EWUM-25	25	57	36	6	14,0	8,5	6,6	10,8	50	42	120	20	79	200	20	119	5,65
EWUM-30	30	69	42	7	17,0	10,5	9,0	11,0	50	51	150	20	94	200	20	119	7,93
EWUM-40	40	73	50	8	17,0	10,5	9,0	15,0	50	55	200	20	119	300	20	169	12,88
EWUM-50	50	84	60	9	19,0	12,5	11,0	19,0	46	63	200	20	119	300	20	169	19,60

⁸⁷⁾ Teilung T1 auf Wunsch, Standard ist T2

Abmessungen [mm] – niedrig unterstützte Edelstahlwellen 1.4125

Art.-Nr.	d	H	H1	A	A1	A2	d1	d2	T	C5/C6		Gewicht
										min.	max.	
	±0,02				±0,02							[kg/m]
EWUMN-12	12	14,5	3	11	5,5	5,4	M4	4,5	75	20	57	1,62
EWUMN-16	16	18	3	14	7,0	7,0	M5	5,5	75	20	57	2,54
EWUMN-20	20	22	3	17	8,5	8,1	M6	6,6	75	20	57	3,81
EWUMN-25	25	26	3	21	10,5	10,3	M8	9,0	75	20	57	5,62
EWUMN-30	30	30	3	23	11,5	11,0	M10	11,0	100	20	69,5	7,63
EWUMN-40	40	39	4	30	15,0	15,0	M12	13,5	100	20	69,5	13,47
EWUMN-50	50	46	5	35	17,5	19,0	M14	15,5	100	20	69,5	20,31

Niedrig unterstützte Wellen werden unmontiert geliefert.



Bestellbeispiel:

EWUMN-16-500 für eine niedrig unterstützte Edelstahlwelle aus 1.4125, Außen-Ø 16 mm mit 500 mm Länge



Bestellschlüssel

Typ Größe Optionen

EWUM-ES-20-2000

Teilunterstützte
Edelstahlwelle,
metrisch

Outer-Ø

Länge der Welle [mm]
(Bohrbild)

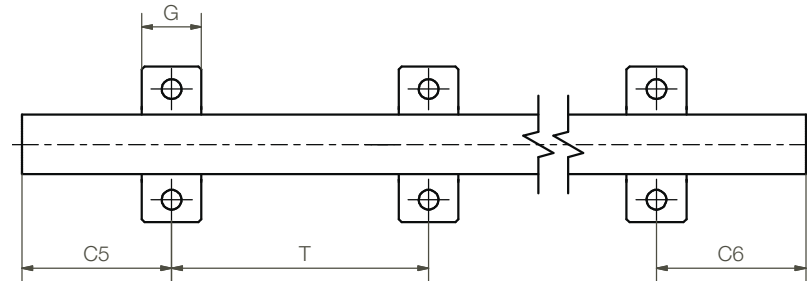
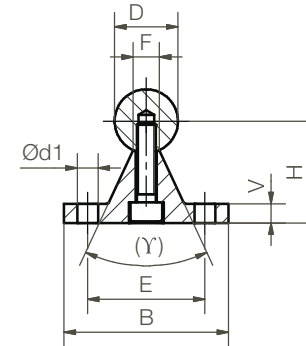
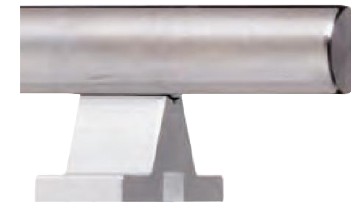

Wellenunterstützungsbocke für
20 mm Ø aus Edelstahl VA

- Anschlussmaße wie Standard-Unterstützungen aus Aluminium

Verfügbare Werkstoffe und Längen:

- 1.4125, max. 6.000 mm ► EWUM
- 1.4571, max. 3.000 mm ► EWUMS

Abmessungen [mm]

Art.-Nr.	Wellenmaterial		D	B	H	V	d1	E	γ	F	G	T	C5/C6		T	C5/C6	
	EWUM	EWUMS											für EW...-ES			für EW...-ES -T1	
	min.	max.											min.	max.		min.	max.
EWUM(S)-ES-12 / ...-T1	1.4125	1.4571	12	40	22	5	4,5	29	-	5,8	14	120	20	79	75	20	57
EWUM(S)-ES-16 / ...-T1	1.4125	1.4571	16	45	26	5	5,5	33	-	7,0	16	150	20	94	100	20	69
EWUM(S)-ES-20 / ...-T1	1.4125	1.4571	20	52	32	6	6,6	37	50°	8,3	20	150	20	94	100	20	69
EWUM(S)-ES-25 / ...-T1	1.4125	1.4571	25	57	36	6	6,6	42	-	10,8	25	200	20	119	150	20	79
EWUM(S)-ES-30 / ...-T1	1.4125	1.4571	30	69	42	7	9,0	51	-	11,0	25	200	20	119	150	20	94
EWUM(S)-ES-40 / ...-T1	1.4125	1.4571	40	73	50	8	9,0	55	-	15,0	25	300	20	169	200	20	119



Bestellbeispiel:

EWUM-ES-20-500 für eine teilunterstützte Edelstahlwelle, Außen-Ø 20 mm mit 500 mm Länge