



Price index



*Noise test values: max. 38 dB(A) -
Values determined at the igus® test-
lab acc. to DIN 45635 (v = 1,8 m/s)



IPA classification - Report IG0704-400: ISO
Class 1, according to standard DIN EN ISO
14644-1 for E3, Series E3.15.040.075.0 (at
v = 0.5 m/s, 1 m/s, 2 m/s)



Special equipment:

Electrically conductive

ESD/ATEX version upon request



Rapid assembly time with "zipperbars on a strip"



When to use the Series E3.10:

- If a low-noise, vibration-free version is required
- At very high speeds and/or accelerations
(Theoretically up to 100 g or 1000 m/s)
- Hard-wearing E-Chain® (more than 50 million
cycles without abrasion)
- If a very light E-Chain® is required (up to 40%
lighter than a comparable E2-E-Chain®)
- For the use of flat cables
- For small bending radii and small spaces
- If easy filling and assembly is required
- Minimal abrasion
(e.g. cleanroom applications)



When not to use it:

- If a particularly low-cost,
snap-open solution is required
- ▶ Series E/Z06 Easy Chain®, page 3.20
- If a simple, non snap-open E-Chain® is required
- ▶ Series 05 E2 micro, page 5.22

- ① Smooth running, due to the igus® approved
"E6-Principle", 38db(A) max.*
- ② For high speed and high accelerations
- ③ Small pitch
- ④ 3-piece Design
- ⑤ Modular design- opening crossbars,
interior separation and link all in one band
- ⑥ Easy cable access due to
fast zip-open mechanism
- ⑦ Easy shortening/lengthening
- ⑧ Suits flat cables
- ⑨ Accessories, such as interior separations, strain
relief and mounting bracket, are available

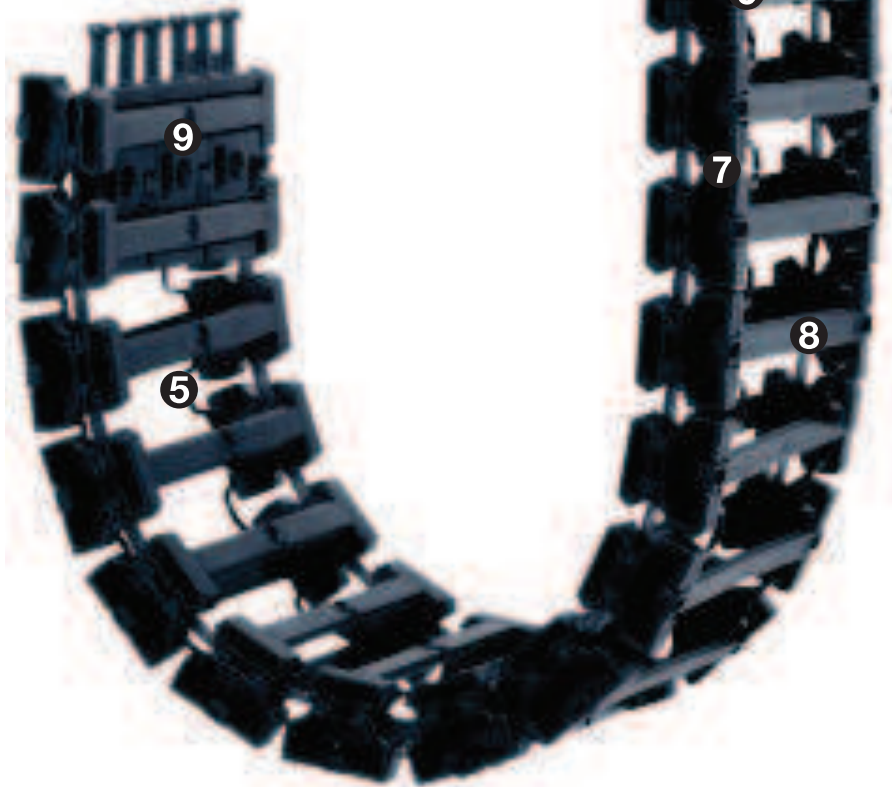

Order example complete E-Chain®

Please indicate chain-lengths or number of links Example: 1 m or 60 links

1 m E3.10.060.015.0



E-Chain®

with 2 separators E3.10.11 assembled every 2nd link

Interior separation

1 set E3.10.060.12



Mounting bracket



Unsupported length

FL_G = with straight upper run

FL_B = with permitted sag

Further information ► **Design, page 1.12**

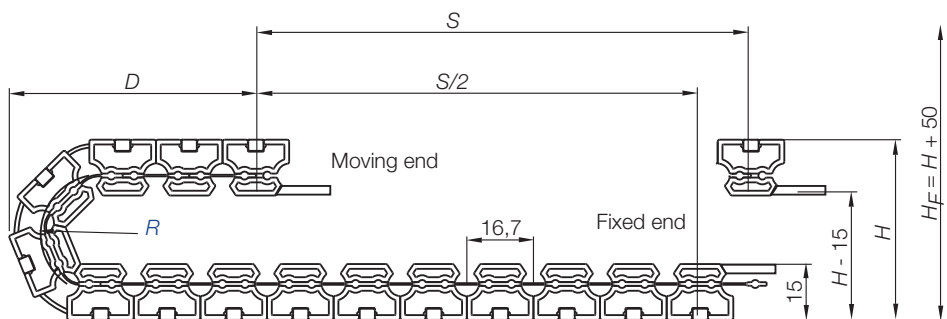
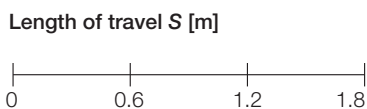
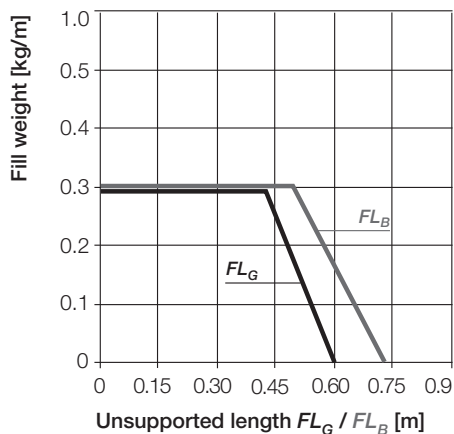
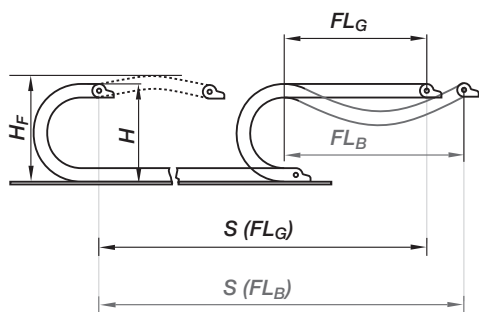

Pitch = 16,7 mm/link Links/m = 60 (1.002 mm) Chain length = $S/2 + K$

R	015	018	028	038	048
H	50	56	76	96	116
D	42	45	55	65	75
K	85	90	125	155	185

- S = Length of travel
- R = Bending radius
- H = Nominal clearance height
- H_F = Required clearance height
- D = Overlength E-Chain® radius in final position
- $K = \pi \cdot R + \text{"safety"}$



Short travels - unsupported

Unsupported E-Chains® feature positive camber over short travels. This must be accounted for when specifying the clearance height H_F . Please consult igus® if space is particularly restricted.

The required clearance height:
 $H_F = H + 50 \text{ mm}$
 (with 0,1 kg/m fill weight)

Speed / acceleration FL_G	max. 20 [m/s] / max. 200 [m/s ²]
Speed / acceleration FL_B	max. 3 [m/s] / max. 6 [m/s ²]
Gliding speed / acceleration (maximum)	upon request
permitted temperature °C	-40° up to +70° C
Flammability class	VDE 0304 IIC UL94 HB

Technical Data



Details of material properties

► page 1.38



System E3
 Inner height: 10 mm

Phone +49- (0) 22 03-96 49-800
 Fax +49- (0) 22 03-96 49-222

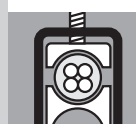

► page 8.9

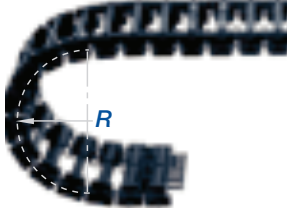
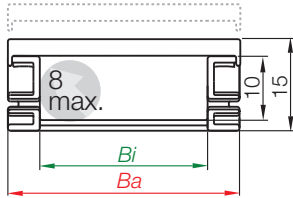

Part No. structure

E3.10.060.015.0



Series E3.10 - snap-open along outer radius

Part No.	B_i [mm]	B_a [mm]	R [mm]	Bending radii					Weight [kg/m]
E3.10.020.	.0	20	32	015	018	028	038	048	≈ 0,12
E3.10.040.	.0	40	52	015	018	028	038	048	≈ 0,15
E3.10.060.	.0	60	72	015	018	028	038	048	≈ 0,20

The bending radii **018** **028** **038** **048**, are available upon request.

Delivery time: approx. 6-8 weeks after receipt of order!

Supplement Part No. with required radius. Example: E3.10.060.015.0

0 = standard color, other colors ► page 1.39 · Pitch = 16,7 mm/link - Links/m = 60



E3 | Series E3.10 | Accessories | Interior Separation

Vertical separator,
slotted (single)

unassembled E3.10.01

assembled E3.10.11

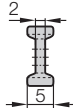

Vertical separators

Vertical separators are used if a vertical subdivision of the E-Chain® interior is required -

- Subdivision with vertical separator E3.10.11 (slotted 3 times)

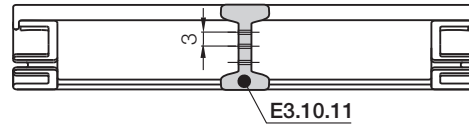



Mounting angle - Polymer

- For fastening the E-Chain® to the fixed end
- Simple fastening to base is possible
- Corrosion-resistant
- Various mounting options
- Easy to assemble

Moving end
E3.10...1

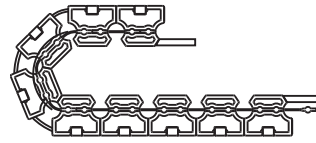

E3.10.....2
Fixed end

Example: Possible installation conditions for E3 mounting brackets

E3.10.....2
Fixed end

E3.10...1
Moving end

Dimensions and order configurations

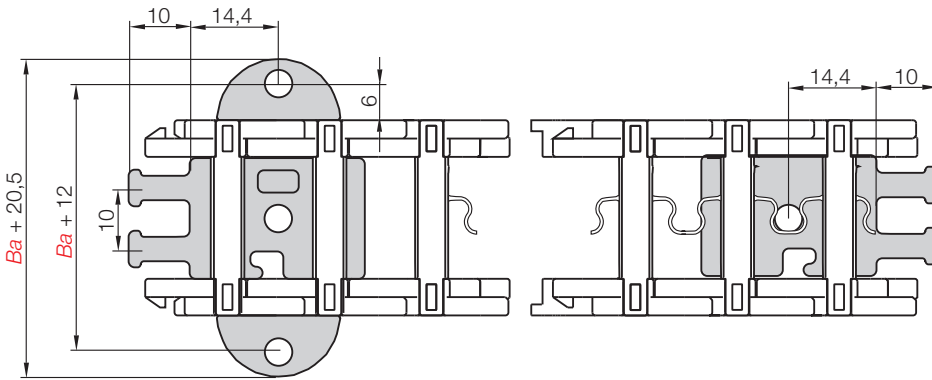

Part No. structure

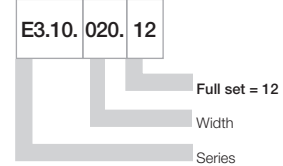

For E-Chain®	Part No. full set strain relief for both sides + 2 mounting angles	Part No. strain relief for both sides	Part No. mounting angle (single part)
E3.10.020.	▶ E3.10.020.12	E3.020.12	E3.10.00
E3.10.040.	▶ E3.10.040.12	E3.040.12	E3.10.00
E3.10.060.	▶ E3.10.060.12	E3.060.12	E3.10.00

Full set, for both ends:

E3.10.020.12

Single-part order:

E3.10.020.1

Moving end mounting bracket

E3.10.020.2

Fixed end mounting bracket

E3.10.XXX.12



E3 with strain relief for both sides and mounting angles

E3.00.020



Strain relief for both sides as single parts

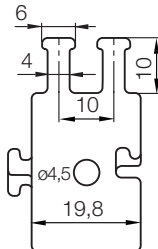

E3.10.00



Mounting angle as single part

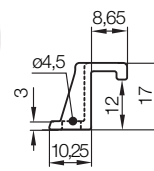

Phone +49- (0) 22 03-96 49-800
Fax +49- (0) 22 03-96 49-222

