

Price index



Side-mounted - unsupported

ESD classification:
Electrically conductive ESD/ATEX version upon request

High torsional rigidity



Opening E-Chains®: Remove crossbars and clips - Insert screwdriver into the slot, push down, release by lever action



Remove lids/bottoms (E-Tubes) - Insert screwdriver into the slot, release by lever action

When to use the Series 3838/3938/R7838:

- When high torsional or shearing forces are expected
- For side-mounted applications involving large unsupported lengths
- For long-term operation in very moist environments
- Also available as Rol E-Chain®

When not to use it:

- If a quieter version is required
▶ Series E4.42, page 7.48

- 1 High side-mount stability due to undercut
- 2 High torsional rigidity
- 3 Closed and open styles can be combined
- 4 Hinged snap-open removable lids along outer radius of E-Tube
- 5 Removable lids along inner radius
- 6 Crossbars on E-Chains® are removable along both radii
- 7 Lateral glide surfaces for side-mounted operation
- 8 Wide, rounded plastic crossbars - cable friendly
- 9 KMA mounting brackets with attachment points on all sides
- 10 Locking or pivoting mounting brackets available
- 11 E-Chain® also available with reverse bending radii



Rol E-Chain® Series 3838R/7838R available upon request



Order example complete E-Chain®
Please indicate chain-lengths or number of links Example: 4 m or 60 links

4 m 3838.30.300.0

E-Chain®

with 2 separators 382 assembled every 2nd link

Interior separation

1 set 38380.30.12C

Mounting bracket



Unsupported length

FL_G = with straight upper run

FL_B = with permitted sag

Further information ► Design, page 1.12

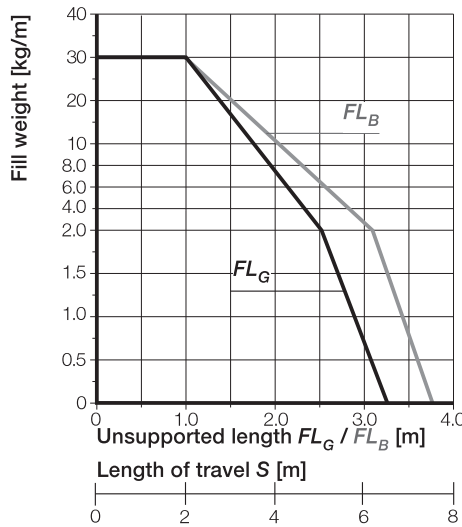
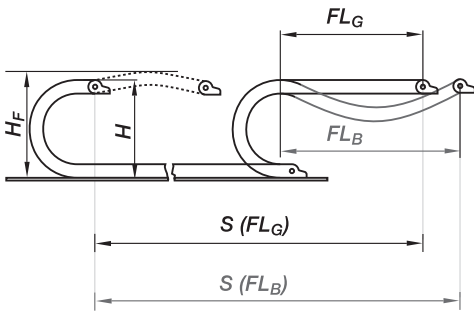

- S = Length of travel
 - R = Bending radius
 - H = Nominal clearance height
 - H_F = Required clearance height
 - H_{RI} = Trough inner height
 - D = Overlength E-Chain® radius in final position
 - K = $\pi \cdot R$ + "safety"
 - D_2 = Over length - long travels, gliding
 - K_2 = *Further add-on
 - H_2 = *Mounting height
- *if the mounting bracket location is set lower

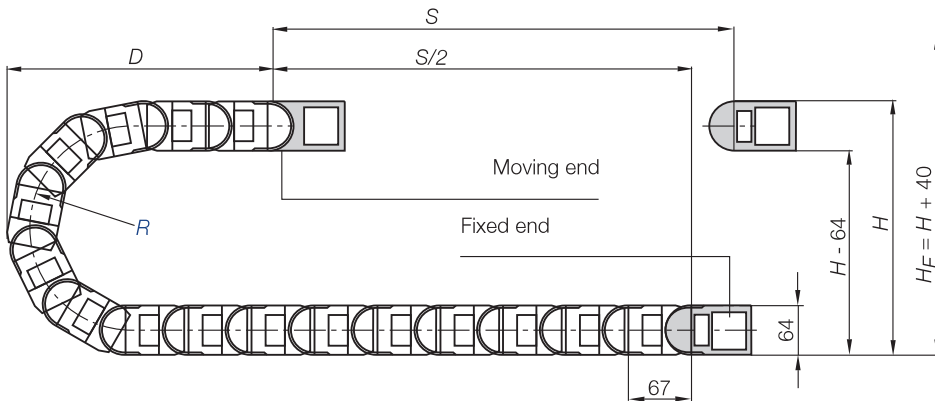

Pitch = 67 mm/link Links/m = 15 (1005 mm) Chain length = $S/2 + K$

R	075	100	115	125	150	170	200	215	250	300	350
H_{-0}^{+25}	215	265	295	315	365	405	465	495	565	665	765
D	174	199	214	224	249	269	299	314	349	399	449
K	370	450	500	530	610	670	765	810	920	1080	1235
H_2	215	265	186	186	186	186	186	186	186	186	186
D_2^{+25}	174	199	435	475	570	690	780	865	1010	1150	1500
K_2	370	450	737	804	1005	1139	1340	1407	1675	1943	2412

Other installation methods

- Vertical, hanging ≤ 100 m
- Vertical, standing ≤ 6 m
- Side mounted, unsp. $\leq 2,5$ m
- Rotary requires further calculation
- Unsupported length of upper run = upon request



Short travels - unsupported

Unsupported E-Chains® feature positive camber over short travels. This must be accounted for when specifying the clearance height H_F . Please consult igus® if space is particularly restricted.

The required clearance height:
 $H_F = H + 40$ mm
(with 2,0 kg/m fill weight)

Long travel lengths from 10 m to max. 280 m Chain length = $S/2 + K_2$

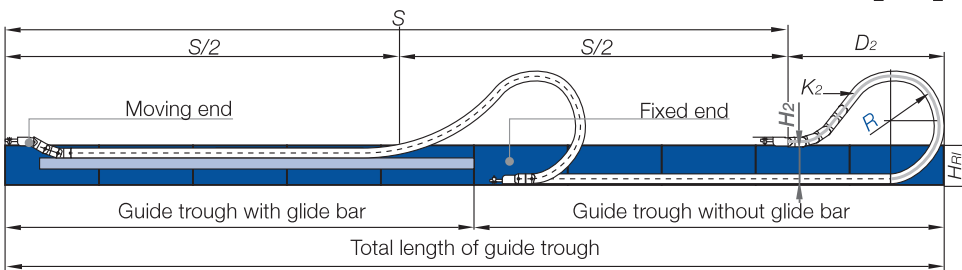

In case of travels between 4 and 10 m we recommend a longer unsupported length.



Gliding, long travel applications (max. 280 m)

In this case the E-Chain® upper run will be introduced in a guide trough on the lower run. We recommend to realize the engineering of such a plant by our technicians.

Technical Data

Speed / acceleration FL_G	max. 20 [m/s] / max. 200 [m/s ²]
Speed / acceleration FL_B	max. 3 [m/s] / max. 6 [m/s ²]
Gliding speed / acceleration (maximum)	max. 10 [m/s] / max. 50 [m/s ²]
Material - permitted temperature °C	igumid G / -40° up to +120° C
Flammability class, igumid G	VDE 0304 IIC UL94 HB



Details of material properties
► page 1.38



For support of the lower run - Support Tray tool kit available ► page 9.70



System E4/4
Inner height: 42 mm

Phone +49- (0) 22 03-96 49-800
Fax +49- (0) 22 03-96 49-222

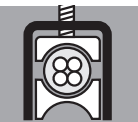

► page 7.223

igus® E-ChainSystems®

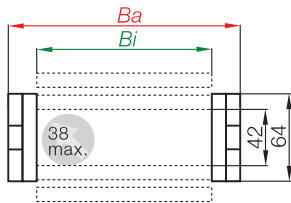

Part No. structure

3838. 400. 300. 0



Series 3838 - E-Chain® with crossbars every link

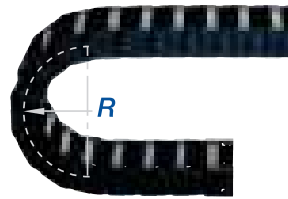

- Crossbars every link
- For rigid hydraulic hoses
- For applications particularly demanding
- Can be opened from two sides



Phone +49- (0) 22 03-96 49-800
Fax +49- (0) 22 03-96 49-222

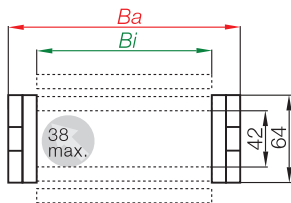

Part No. structure

3938. 400. 300. 0



Series 3938 - E-Chain® with crossbars every 2nd link

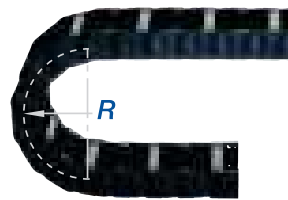

- Crossbars every 2nd link = Standard
- For nearly every situation
- Can be opened from two sides
- Easy assembly
- Stable
- Attractive price



igus® GmbH
51147 Cologne

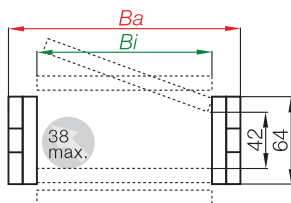

Part No. structure

7838. 25. 300. 0



Series R7838 - Fully enclosed E-Tube

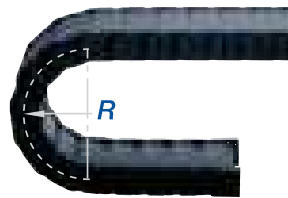

- Fully enclosed
- Excellent cable protection against dirt
- Protection against hot chips (up to 900°C)
- Lids along the entire inner radius are completely removable. Lids along the entire outer radius are single sided snap-open with a hinge on the other side to keep them attached to the chain or completely removable.



Internet: www.igus.eu
E-mail: info@igus.de

Rol instead of gliding: Rol E-Chain®

Special solution for long travels. 75% less drive power (gliding application) with igus® Rol E-Chain®.
Series 3838R - Order example - 3838R.30.250.0
Further information: www.igus.de/en/role
or phone: +49-0 22 03-96 49-800

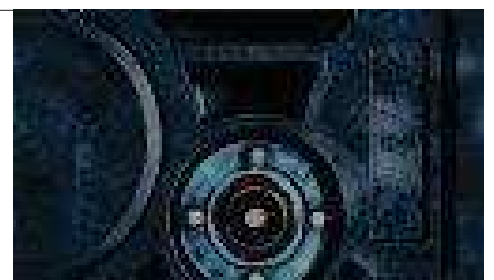

Part No.	<i>Bi</i> [mm]	<i>Ba</i> [mm]	3838 [kg/m]	3938 [kg/m]	R7838 [kg/m]
3838/3938/7838.05... <input type="checkbox"/> .0*	50	77	≈ 2,06	≈ 1,98	≈ 2,25
3838/3938.06..... <input type="checkbox"/> .0	68	95	≈ 2,09	≈ 1,99	-
3838/3938/7838.07... <input type="checkbox"/> .0	75	102	≈ 2,12	≈ 2,01	≈ 2,38
3838/3938.087..... <input type="checkbox"/> .0	87	115	≈ 2,18	≈ 2,04	-
3838/3938/7838.10... <input type="checkbox"/> .0	100	127	≈ 2,25	≈ 2,08	≈ 2,60
3838/3938/7838.11... <input type="checkbox"/> .0	108	135	≈ 2,30	≈ 2,10	≈ 2,65
3838/3938.112..... <input type="checkbox"/> .0	112	140	≈ 2,30	≈ 2,10	-
3838/3938/7838.12... <input type="checkbox"/> .0	125	152	≈ 2,40	≈ 2,15	≈ 2,81
3838/3938.137..... <input type="checkbox"/> .0	137	165	≈ 2,44	≈ 2,17	-
3838/3938/7838.15... <input type="checkbox"/> .0	150	177	≈ 2,53	≈ 2,21	≈ 3,07
3838/3938.162..... <input type="checkbox"/> .0	162	190	≈ 2,55	≈ 2,22	-
3838/3938/7838.17... <input type="checkbox"/> .0	168	195	≈ 2,62	≈ 2,26	≈ 3,24
3838/3938.18..... <input type="checkbox"/> .0	175	202	≈ 2,62	≈ 2,26	-
3838/3938.187..... <input type="checkbox"/> .0	187	215	≈ 2,69	≈ 2,30	-
3838/3938/7838.20... <input type="checkbox"/> .0	200	227	≈ 2,77	≈ 2,33	≈ 3,53
3838/3938.212..... <input type="checkbox"/> .0	212	240	≈ 2,84	≈ 2,37	-
3838/3938.23..... <input type="checkbox"/> .0	225	252	≈ 2,92	≈ 2,41	-
3838/3938.237..... <input type="checkbox"/> .0	237	265	≈ 2,96	≈ 2,43	-
3838/3938/7838.25... <input type="checkbox"/> .0	250	277	≈ 3,05	≈ 2,47	≈ 4,33
3838/3938.262..... <input type="checkbox"/> .0	262	290	≈ 3,06	≈ 2,48	-
3838/3938.28..... <input type="checkbox"/> .0	275	302	≈ 3,17	≈ 2,53	-
3838/3938.29..... <input type="checkbox"/> .0	287	315	≈ 3,19	≈ 2,54	-
3838/3938/7838.30... <input type="checkbox"/> .0	300	327	≈ 3,32	≈ 2,61	≈ 4,89
3838/3938.312..... <input type="checkbox"/> .0	312	340	≈ 3,34	≈ 2,62	-
3838/3938.325..... <input type="checkbox"/> .0	325	352	≈ 3,41	≈ 2,66	-
3838/3938.337..... <input type="checkbox"/> .0	337	365	≈ 3,46	≈ 2,68	-
3838/3938.350..... <input type="checkbox"/> .0	350	377	≈ 3,68	≈ 2,79	-
3838/3938.362..... <input type="checkbox"/> .0	362	390	≈ 3,74	≈ 2,82	-
3838/3938.375..... <input type="checkbox"/> .0	375	402	≈ 3,79	≈ 2,84	-
3838/3938.387..... <input type="checkbox"/> .0	387	415	≈ 3,85	≈ 2,87	-
3838/3938.400..... <input type="checkbox"/> .0	400	427	≈ 3,90	≈ 2,90	-

Available bending radii
R [mm] 075** 100** 115** 125 150 170 200 215 250 300 350

Supplement Part No. with required radius. Example: 3838.400.300.0

0 = standard color, other colors ► page 1.39 · Pitch = 67 mm/link - Links/m = 15

*Removable lid only, no hinged option · **not available for R7838

Hot Chips up to 850°C

E-Tubes that repel hot chips, up to 850°C. Some applications, depending on amount and size of the chips, can burn or melt the surface. That is no longer the case with the igus® "igumid HT" material. Order example: Full E-Tube made of HT*: **7838.30.150.0.HT**
 Lids made of HT: **7838.30.HTE.150.0**

*for long travels upon request
 Further Information: www.igus.de/en/HT
Delivery time up to 4 weeks!



System E4/4
 Inner height: 42 mm

Phone +49- (0) 22 03-96 49-800
 Fax +49- (0) 22 03-96 49-222

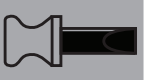
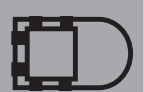

► page 7.223

 Extender crossbar for large diameter hoses ► page 7.242

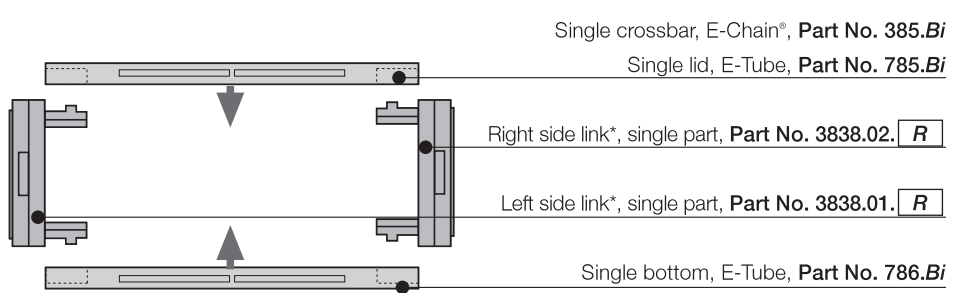

Part No. E-Chain® - links, single parts
 *View from the fixed point of the E-Chain®/E-Tube

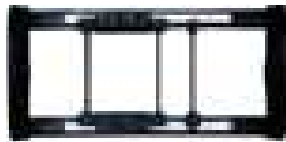

Vertical separators are used if a vertical subdivision is required. In the standard configuration, a separator is mounted at every second link. **Note:** Observe a lateral spacing of at least 25 mm (E-Tube)!

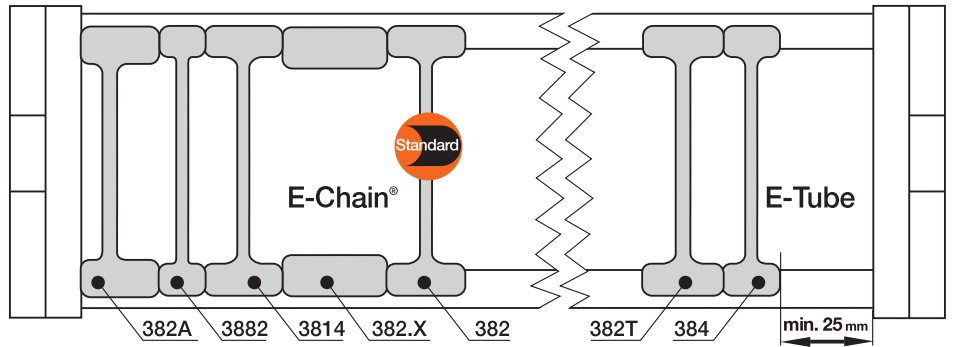

Vertical separator 381



Vertical separator with a narrow base 3881



Vertical separator 381T



Spacer 381.XX



Locking separator 3804



Locking separator 383



Asymmetric separator 381A

Vertical separator for E-Chains®	
unassembled	381
assembled	382

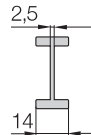

Vertical separator* for E-Chains®	
unassembled	3881
assembled	3882

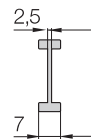

Vertical separator for E-Tubes	
unassembled	381T
assembled	382T

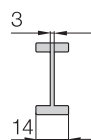

Spacer* for E-Chains®	
unassembled	381.XX
assembled	382.XX

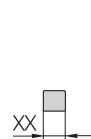

Locking separator for E-Chains®	
unassembled	3804
assembled	3814

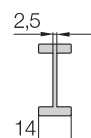

Locking separator for E-Tubes	
unassembled	383
assembled	384

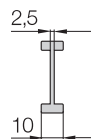

Asymmetric separator for E-Chains®	
unassembled	381A
assembled	382A

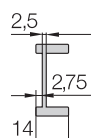

*For side-mounted applications

Option 1: Vertical separators and spacers

- **Standard separator 381 for E-Chains®** offers safe stability due to its broad foot design, also when used with thick cables or hoses.
- **Vertical separator 3881 with a narrow foot (7 mm) for E-Chains®** with applications where a large number of small cables need to be individually separated.
- The **vertical separator 381T for E-Tubes** clamps to the fixed radius and remains free along the other radius to facilitate lid removal. If installing these yourself, please ensure that they are identically aligned.
- Separators (e.g. "side mounted") for E-Chains® can be fixed in their position with **spacers 381.XX**. The available inner height will be reduced by 2 mm, per spacer and side. To avoid this, the parts can be assembled on outside of the crossbar (not for long travels) **XX = width of the spacer** (available 10, 15 and 20)

Additionally:

- **Locking separator 3804 for E-Chains®** - with increased retention force for applications exposed to very high humidity or extreme loads. The extra retention force is achieved by asymmetric claws for the crossbar. Ensure proper alignment.
- **Locking separator 393 for E-Chains®** - with increased retention force for applications exposed to very high humidity or extreme loads. The extra retention force is achieved by asymmetric claws for the crossbar. Ensure proper alignment.
- **Asymmetric separator 381A for E-Chains®** (not for E-Tubes) with an 14-mm base, for combinations between spacers of different widths and vertical separators in side-mounted

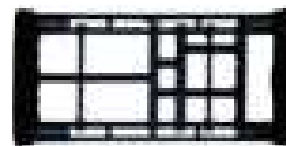
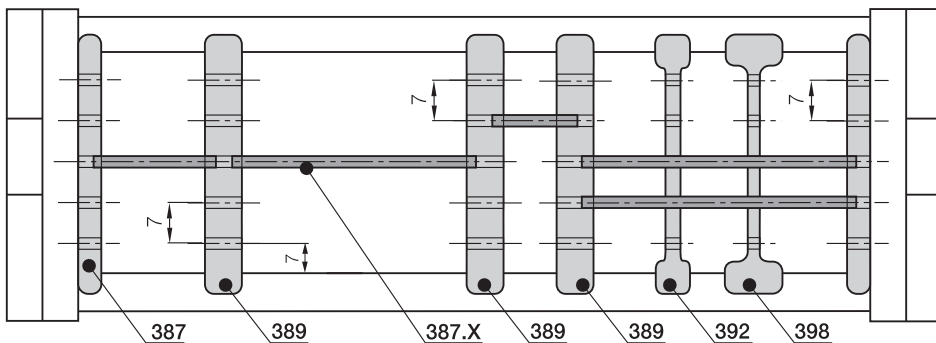

For use with many cables of differing diameters. E-Chains® and E-Tubes can be subdivided both vertically and horizontally. The shelves can be arranged elevator-shifted with different bottoms

Option 2: Shelves

● Side plates 386, middle plates 388 and shelves 386.X form the basic pattern of a shelf system. Shelves of various widths can be arranged at 5 different heights (in 7 mm increments).

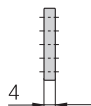

Side plate for E-Chains®/E-Tubes	
unassembled	386
assembled	387

● Slotted separators 391 are used for very fine subdivisions. However, they cannot be retrofitted into an existing separation system without dismantling the interior separators first.

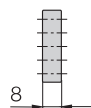

Middle plate for E-Chains®/E-Tubes	
unassembled	388
assembled	389

● The unilateral open slotted separator 397 can be retrofitted into an existing interior separation system without a need for dismantling the interior separators. During an installation of open slotted separators, the top and bottom notches cannot be occupied by shelves.

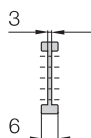

Slotted separator for E-Chains®/E-Tubes	
unassembled	391
assembled	392

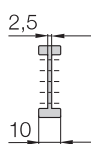

Open slotted separator for E-Chains®/E-Tubes	
unassembled	397
assembled	398



Side plate 386



Middle plate 388



Slotted separator 391



Open slotted separator 397

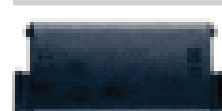

Shelf 386.X

Shelf

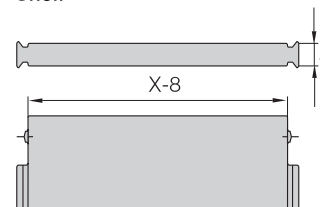

Width X [mm]	Part No. unassembled	Part No. assembled
018	386.18	387.18
023	386.23	387.23
025	386.25	387.25
028	386.28	387.28
033	386.33	387.33
043	386.43	387.43
050	386.50	387.50
054	386.54	387.54
062	386.62	387.62

Width X [mm]	Part No. unassembled	Part No. assembled
075	386.75	387.75
087	386.87	387.87
100	386.100	387.100
108	386.108	387.108
125	386.125	387.125
150	386.150	387.150
175	386.175	387.175
200	386.200	387.200
208	386.208	387.208

System E4/4
Inner height: 42 mm

Phone +49- (0) 22 03-96 49-800
Fax +49- (0) 22 03-96 49-222

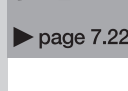

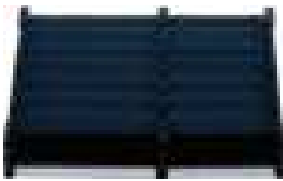
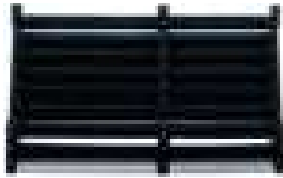

Part No. structure
3838.10 /20 /10. .0
3838.Bi1/Bi2/Bi3. .0

Extension links - for extremely wide E-Chains® up to 3,0 m

- For applications in which particularly high fill weights necessitate extremely wide E-Chains® (up to 3000 mm)
- The extension link design allows virtually limitless side-by-side attachment of chains
- The unsupported length of a chain can be increased when additional loads are required
- Extension links can be used with E-Chains®, E-Tubes or as a combination of both
- They are suitable for unsupported and gliding applications in a guide trough
- E-Chains® with extension links are attached with KMA or steel mounting brackets

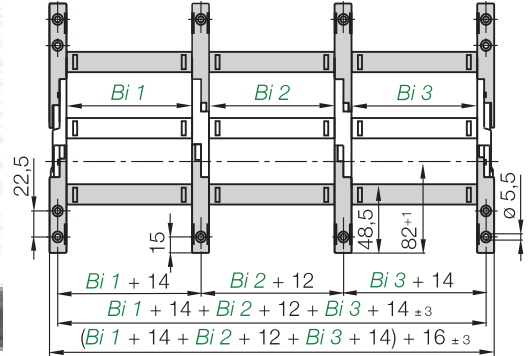
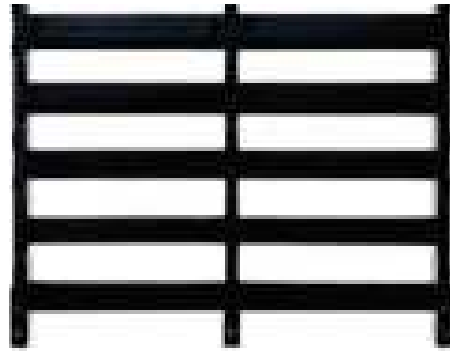

Consult igus® for your extender crossbar applications. We are happy to assist you with your design layout

Extender crossbars - careful guide of hoses applications

- Suitable for hoses with a maximum outer diameter of 115 mm
- Gliding operation with crossbars assembled along the outer radius and a special guide trough
- Gliding operation not guaranteed with crossbars assembled along the inner radius
- The extender crossbar can either be attached to the side links directly or can be used in combination with two stranded snap-open crossbars

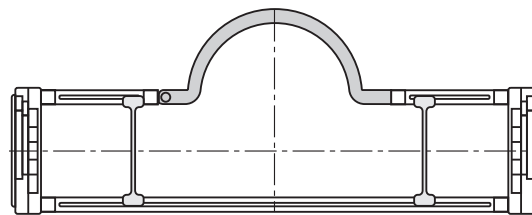

385.15RHD115 round extender crossbar combined with snap-open crossbars

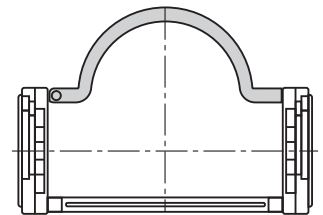

385.18RD115 round strap assembled directly on the side section

Part No.	Max Ø [mm] hose	Form	Installation side link	Combination with snap-open crossb.
385.15.RHD115	115	○	-	+
385.18.RD115	115	○	+	-

○ = round + = yes / - = no



Hinged crossbars

- Typically E-Chain® crossbars are completely removable. In cases where the snap-open crossbars have to remain at the open link of the E-Chain®, a hinged design has been developed
- Length: 37,5 mm **Part No. 385.02** / snap-open crossbar (shortened): $Bi-37,5$ mm **Part No. 385.03**
- Please consult igus® for design assistance

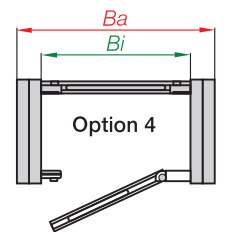
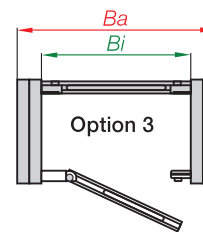
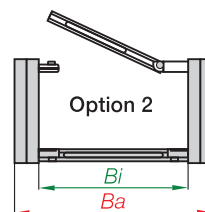
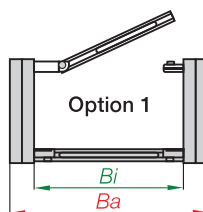
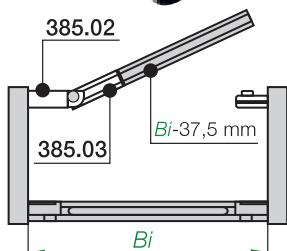

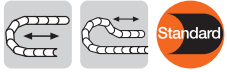

The Standard - Option KMA* - pivoting

- Recommended for unsupported and gliding applications
- Confined installation conditions
- Option - integrated C-profile strain relief device with Chainfix clip or strain relief tiwrap plates
- Corrosion resistant
- Universal mountable with attachment capability on all sides

*KMA = Polymer Metal Mounting Bracket

Moving end
38380/78380...1

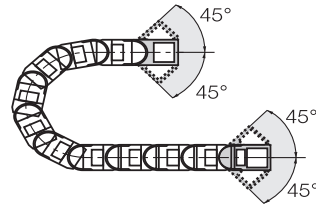

Fixed end
38380/78380...2

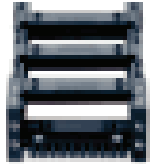

The attachment variants arising automatically by the choice of the KMA mounting bracket

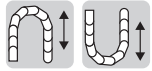
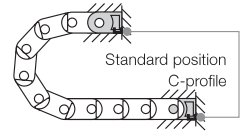

Option KMA - locking

- Recommended for vertical hanging / standing applications

Additionally:

- Universal mountable
- C-profile option
- Corrosion resistant
- Locked connections
- At very high acceleration

Moving end
39380/79380...1

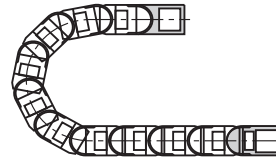

Fixed end
39380/79380...2



The attachment variants arising automatically by the choice of the KMA mounting bracket

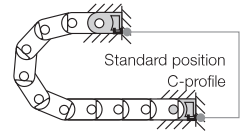

Fixed end
38380/78380...2 (pivoting)
39380/79380...2 (locking)

Moving end
(pivoting) 38380/78380...1
(locking) 39380/79380...1

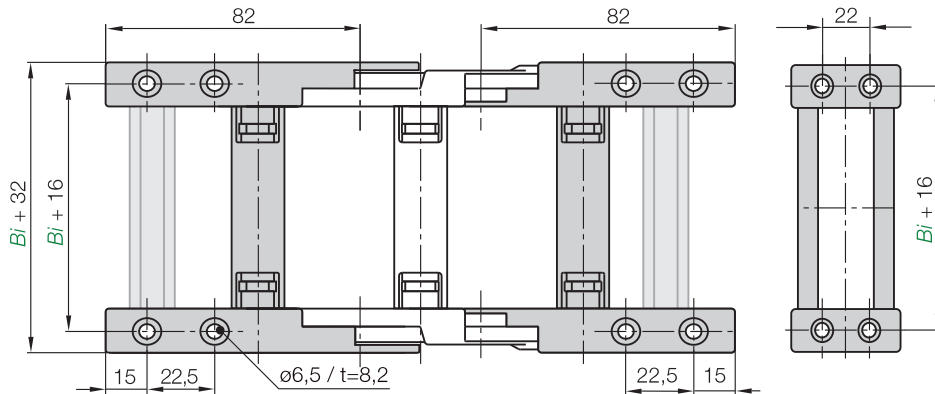

Dimensions and order configurations

Part No. structure (pivoting)

38380.	05.	12.	C
78380.			

Optional with C-profile
Full set
Width
38380 = E-Chain®
78380 = E-Tube

Part No. structure (locking)

39380.	05.	12.	C
79380.			

Optional with C-profile
Full set
Width
38380 = E-Chain®
77380 = E-Tube

Width index	Part No. full set pivoting	Part No. full set locking	C-profile option [mm]	Bi	Width index	Part No. full set pivoting	Part No. full set locking	C-profile option [mm]	Bi
.05.	38380/78380	39380/79380	.05.12.C	50	.23.	38380	39380	.23.12.C	225
.06.	38380	39380	.06.12.C	68	.237.	38380	39380	.237.12.C	237
.07.	38380/78380	39380/79380	.07.12.C	75	.25.	38380/78380	39380/79380	.25.12.C	250
.087.	38380	39380	.087.12.C	87	.262.	38380	39380	.262.12.C	262
.10.	38380/78380	39380/79380	.10.12.C	100	.28.	38380	39380	.28.12.C	275
.11.	38380/78380	39380/79380	.11.12.C	108	.29.	38380	39380	.29.12.C	287
.112.	38380	39380	.112.12.C	112	.30.	38380/78380	39380/79380	.30.12.C	300
.12.	38380/78380	39380/79380	.12.12.C	125	.312.	38380	39380	.312.12.C	312
.137.	38380	39380	.137.12.C	137	.325.	38380	39380	.325.12.C	325
.15.	38380/78380	39380/79380	.15.12.C	150	.337.	38380	39380	.337.12.C	337
.162.	38380	39380	.162.12.C	162	.350.	38380	39380	.350.12.C	350
.17.	38380/78380	39380/79380	.17.12.C	168	.362.	38380	39380	.362.12.C	362
.18.	38380	39380	.18.12.C	175	.375.	38380	39380	.375.12.C	375
.187.	38380	39380	.187.12.C	187	.387.	38380	39380	.387.12.C	387
.20.	38380/78380	39380/79380	.20.12.C	200	.400.	38380	39380	.400.12.C	400
.212.	38380	39380	.212.12.C	212					

Full set, for both ends:

38380.05.12

Single-part order:

38380.05.1

Mounting bracket moving end

38380.05.2

Mounting bracket fixed end



Option steel - pivoting

- For pivoting connections
- One part (two-piece) for all chain widths
- Electrically conductive

Moving end
38380.1

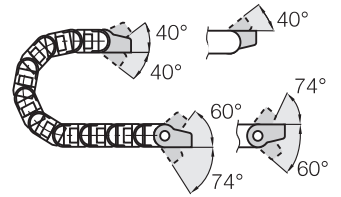

Fixed end
38380.2

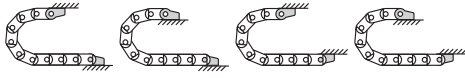

Possible installation conditions -

Further installation angles ► installation sketch

Phone +49- (0) 22 03-96 49-800
Fax +49- (0) 22 03-96 49-222

igus® GmbH
51147 Cologne

Internet: www.igus.de
E-mail: info@igus.de

Moving end
38380.1

Fixed end
38380.2

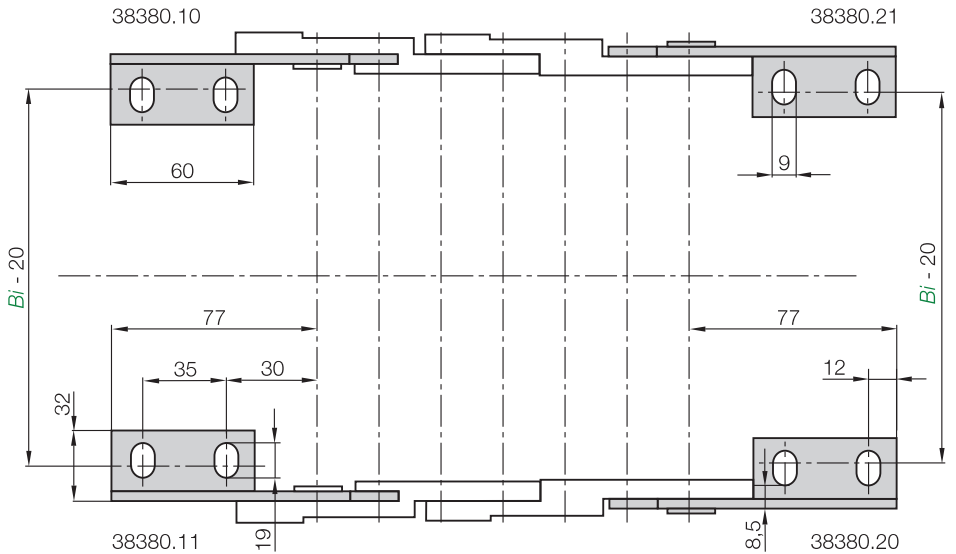

For E-Chain®	Part No. full set	Bi [mm]	For E-Chain®	Part No. full set	Bi [mm]
3838-3938-7838.05	38380.12	50	3838-3938.23	38380.12	225
3838-3938.06	38380.12	68	3838-3938.237	38380.12	237
3838-3938-7838.07	38380.12	75	3838-3938-7838.25	38380.12	250
3838-3938.087	38380.12	87	3838-3938.262	38380.12	262
3838-3938-7838.10	38380.12	100	3838-3938.28	38380.12	275
3838-3938-7838.11	38380.12	108	3838-3938.29	38380.12	287
3838-3938.112	38380.12	112	3838-3938-7838.30	38380.12	300
3838-3938-7838.12	38380.12	125	3838-3938.312	38380.12	312
3838-3938.137	38380.12	137	3838-3938.325	38380.12	325
3838-3938-7838.15	38380.12	150	3838-3938.337	38380.12	337
3838-3938.162	38380.12	162	3838-3938.350	38380.12	350
3838-3938-7838.17	38380.12	168	3838-3938.362	38380.12	362
3838-3938.18	38380.12	175	3838-3938.375	38380.12	375
3838-3938.187	38380.12	187	3838-3938.387	38380.12	387
3838-3938-7838.20	38380.12	200	3838-3938.400	38380.12	400
3838-3938.212	38380.12	212			

38380.12 Full set, 4 parts
2 with pin / 2 with bore

Single-part order:

38380.1 Mounting bracket
moving end, 1 part left / right

38380.2 Mounting bracket
fixed end, 1 part left / right

Other strain relief elements
► chapter 10

Chainfix clamps for the C-profile

Part No. single clamps		Part No. double clamps		Part No. triple clamps		Cable
steel	stainless steel	steel	stainless steel	steel	stainless steel	ø [mm]
CFX12.1	CFX12.1.E	CFX12.2	CFX12.2.E	CFX12.3	-	06 - 12
CFX14.1	CFX14.1.E	CFX14.2	CFX14.2.E	CFX14.3	-	12 - 14
CFX16.1	CFX16.1.E	CFX16.2	CFX16.2.E	CFX16.3	-	14 - 16
CFX18.1	CFX18.1.E	CFX18.2	CFX18.2.E	CFX18.3	-	16 - 18
CFX20.1	CFX20.1.E	CFX20.2	CFX20.2.E	CFX20.3	-	18 - 20
CFX22.1	CFX22.1.E	CFX22.2	CFX22.2.E	CFX22.3	-	20 - 22
CFX26.1	CFX26.1.E	CFX26.2	CFX26.2.E	-	-	22 - 26
CFX30.1	CFX30.1.E	CFX30.2	CFX30.2.E	-	-	26 - 30
CFX34.1	CFX34.1.E	CFX34.2	CFX34.2.E	-	-	30 - 34
CFX38.1	CFX38.1.E	-	-	-	-	34 - 38
CFX42.1	CFX42.1.E	-	-	-	-	38 - 42



igus® Chainfix steel clamps and Chainfix stainless-steel clamps - max. pull forces, adjustable with hexagon socket. Available as single, double or triple clamps. **Details ▶ chapter 10**

System E4/4
Inner height: 42 mm

Cable ø [mm]	Part No. clamp	Part No. bottom part
04 - 08	CFC-08-M	CFC-08-C
08 - 12	CFC-12-M	CFC-12-C
12 - 16	CFC-16-M	CFC-16-C
16 - 20	CFC-20-M	CFC-20-C
20 - 24	CFC-24-M	CFC-24-C

Chainfix Clip - Modular snap-on strain relief device for C-profile

Available for all igus® E-ChainSystems® with C-profiles and also suitable for assembly in the KMA mounting brackets and clip-on strain relief for crossbars. High pull forces, plug-in modular snap-on strain relief device. **Details ▶ chapter 10**



Part No.	ø max. conduit [mm]	Width [mm]
CFN.20	20	10,8
CFN.30.52	30	16,8
CFN.20.N35	20	20,0

Chainfix Nugget for the C-Profile

Strain relief for the fixation of cables up to a diameter of Ø 30 mm. Easy to assemble, without any screws and tools. Easy strain relief due to fixation with pre-harnessed cable strap, very small space requirement. **Details ▶ chapter 10**



Part No.	Width of strain relief [mm]	Number of teeth
3050.ZC	50	5
3075.ZC	75	7

Chainfix tiwrap plates with clip-on connection for the C-profile

Can be plugged into the KMA C-profile. Easy to assemble without any screws. Easily solvable with screwdriver nevertheless safe stop. For all E-Chains® with KMA and integrated C-profile. **Details ▶ chapter 10**

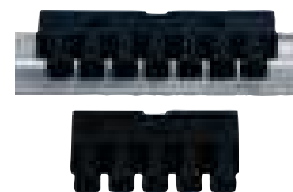

Tiewrap plate	No. of teeth n	Dim. C [mm]	Dim. B [mm]	Center bore
3050.ZB	5	50	30	-
3075.ZB	7	75	55	-
3100.ZB	10	100	80	-
3115.ZB	11	115	95	-
3125.ZB	12	125	105	-
3150.ZB	15	150	130	-
3175.ZB	17	175	155	-
3200.ZB	20	200	180	+
3225.ZB	22	225	205	+
3250.ZB	25	250	230	+

(- = no / + = yes)

Tiewrap plate as individual part

As individual component screwed on KMA. Can be plugged in the mounting brackets. **Details ▶ chapter 10**

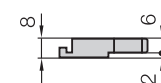
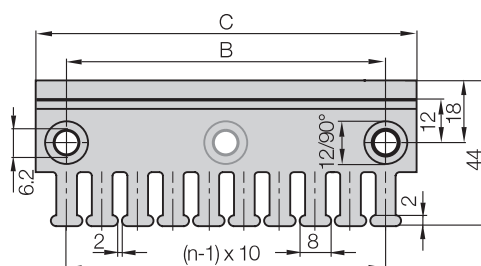

Single tiwrap plate

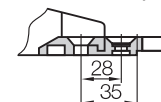

Shown assembled

Details about all strain relief option for this series ▶ chapter 10

Phone +49- (0) 22 03-96 49-800
Fax +49- (0) 22 03-96 49-222



▶ Chapter 10



▶ page 7.223

- B_a = Outer width E-Chains® / E-Tube
- B_i = Inner width E-Chains® / E-Tube
- h_a = Outer height E-Chains® / E-Tube
- H_{Ri} = Inner trough height
- H_{Ra} = Outer trough height
- B_{Ri} = Inner trough width ▶ depends on dim. B_a
- B_{Ra} = Outer trough width
- n_{Mon} = Number of installation sets (left/right)
- n_{Ri} = Number of troughs sets (left/right)
- ! $H_{Ri} \geq 2 \cdot h_a$
- ! $B_{Ri} \geq B_a + 4$
- = Guide trough set ● = Glide bar
- = Installation set "Basic" ● = C-profile

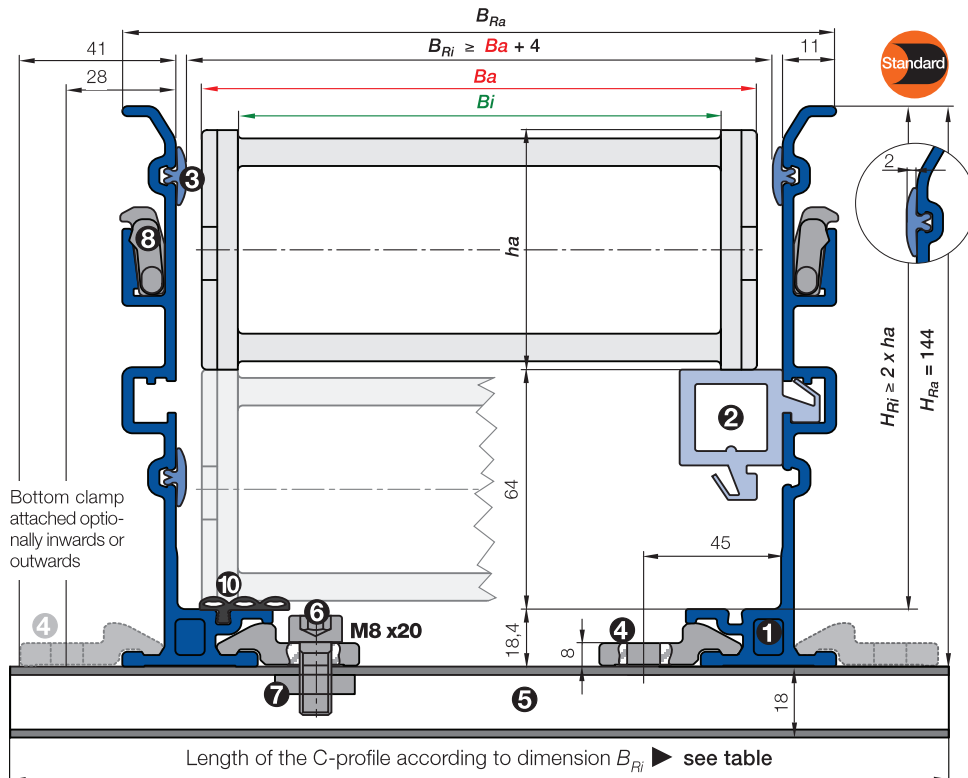

Installation set "Basic" with C-profile

Bottom Clamp attached optionally inwards or outwards

3838.05.300.0 ▶ Order example

	B_{Ri} [mm]	Part No.	
		attached inwards	attached outwards
.05	81	-	960.40.200
.06	99	-	960.40.225
.07	106	-	960.40.225
.087	119	960.40.175	960.40.250
.10	131	960.40.200	960.40.250
.11	139	960.40.200	960.40.275
.112	144	960.40.200	960.40.275
.12	156	960.40.225	960.40.275
.137	169	960.40.225	960.40.300
.15	181	960.40.250	960.40.300
.162	194	960.40.250	960.40.325
.17	199	960.40.250	960.40.325
.18	206	960.40.275	960.40.325
.187	219	960.40.275	960.40.350
.20	231	960.40.300	960.40.350
.212	244	960.40.300	960.40.375
.23	256	960.40.325	960.40.375
.237	269	960.40.325	960.40.400
.25	281	960.40.350	960.40.400
.262	294	960.40.350	960.40.425
.28	306	960.40.375	960.40.425
.29	319	960.40.375	960.40.450
.30	331	960.40.400	960.40.450
.312	344	960.40.400	960.40.475
.325	356	960.40.425	960.40.475
.337	369	960.40.425	960.40.500
.350	381	960.40.450	960.40.500
.362	394	960.40.450	960.40.525
.375	406	960.40.475	960.40.525
.387	419	960.40.475	960.40.550
.400	431	960.40.500	960.40.550

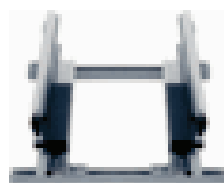

- Components, trough "Basic": ① Trough side parts, aluminum, 2 m ② Glide bar, plastic, 2 m ③ Glide strips, plastic, 2 m (without glide strips on request) ⑩ Optional: Silencer profile, rubber
- Components, installation set "Basic": ④ Bottom clamp, aluminum ⑤ C-profile, steel galvanized ⑥ Screw M8 x20 ⑦ Sliding nut M8 ⑧ Interface connector, plastic



Order example: Length of travel 30 m - Center mounted for Series 3838.20.300.0 with $B_{Ri} = 231$

- Guide trough set (set of 2 trough side parts, incl. glide strips) **without** glide bar
Order text: 16 m guide trough without glide bar (8 x 2 m sections) Part No. 973.30.SL
- Guide trough set (set of 2 trough side parts, incl. glide strips) **with** glide bar
Order text: 16 m guide trough with glide bar (8 x 2 m sections) Part No. 973.31.SL
- Installation set "Basic" complete (guide trough-sets + 1)
Order text: 17 installation sets "Basic" Part No. 960.40.300
- Module for the fixed end
Order text: 1 set Part No. 973.81
- Option: For an additional noise dampening with silencer profile, please add Index A - Example: Part No. 973.30.SLA

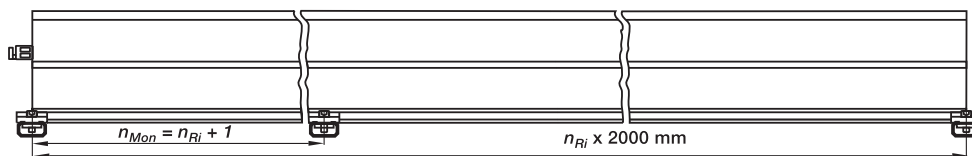

Principle sketch: Number of installation sets to be installed = Number of trough sections + 1



A quick fix for mounting the stationary end of an E-Chain®

With this module for the fixed end, fast and easy mounting onto the Aluminum "SuperTrough" is now possible without any drilling. Fast mounting of the E-Chain® by clamping onto the aluminum trough

- Quick relocation of the stationary end
- No drilling necessary ▶ page 9.16

Insert for the installation set "Heavy-Duty": 973.50.XXX instead of (960.40.XXX) on the right column "attached outwards"

Phone +49- (0) 22 03-96 49-800
Fax +49- (0) 22 03-96 49-222

igus® GmbH
51147 Cologne

Internet: www.igus.eu
E-mail: info@igus.de



E4/4 as ZigZag version in this crane. The E4-Series guarantee very high availability of the facility, so that the production of new truck can be started up on an average of every seven minutes

System E4/4
Inner height: 42 mm

Phone +49- (0) 22 03-96 49-800
Fax +49- (0) 22 03-96 49-222



▶ Chapter 9



▶ page 7.223