

Zipper | E-Tubes | Series R17

● ● ● Price index



Upon request: Cleanroom Class 1
(ISO class 3) tested by the Dryden
Engineering Company, California



UL94-V2 classifications
upon request



Low-noise



"Zipper-fast" opening and closing

- ① "Zipper-fast" opening and closing
- ② Small pitch for low-noise, smooth operation
- ③ For high acceleration
- ④ Zipper lids can be separated and joined at each chain link
- ⑤ Mounting bracket with integrated strain relief
- ⑥ Smooth exterior and interior
- ⑦ Large pivot pins for long service life
- ⑧ Also available as "Zipper" E-Chain® Series 17 ► page 4.24

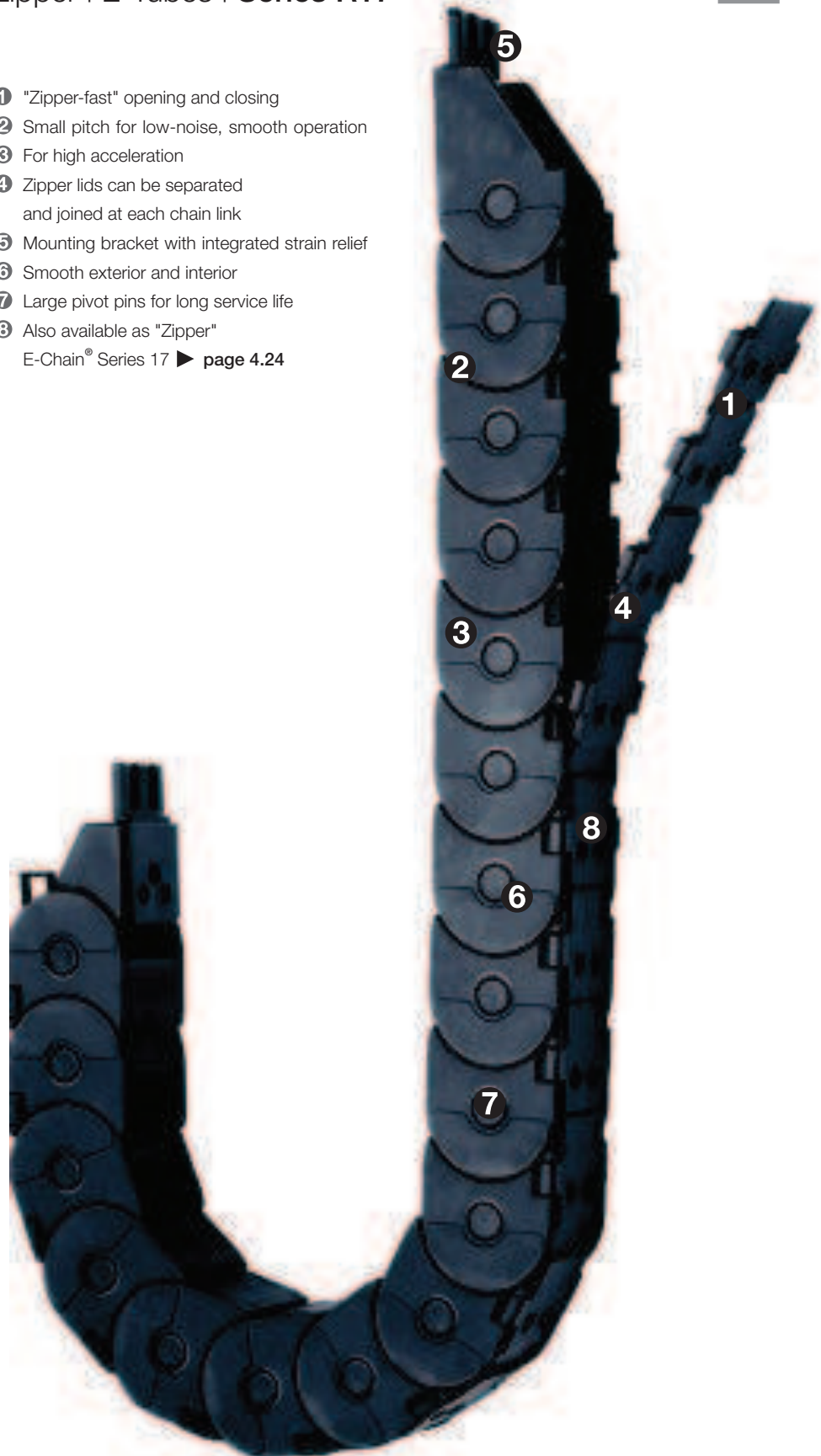

When to use the Series R17:

- If extremely quick, zipper-like access to cables is required
- If chip protection is required
- If quick, easy insertion of cables with preassembled connectors is required
- If aesthetic design is required



When not to use it:

- If cable installation without opening lids is possible
- Series E16 Easy Chain®, page 3.42



Order example complete E-Tube

Please indicate chain-lengths or number of links Example: 1 m or 33 links

1 m R17.025.063.0

E-Chain®

with 2 separators R172 assembled every 2nd link

Interior separation

1 set 117.025.12PZ

Mounting bracket



Unsupported length

FL_G = with straight upper run

FL_B = with permitted sag

Further information ► **Design, page 1.12**

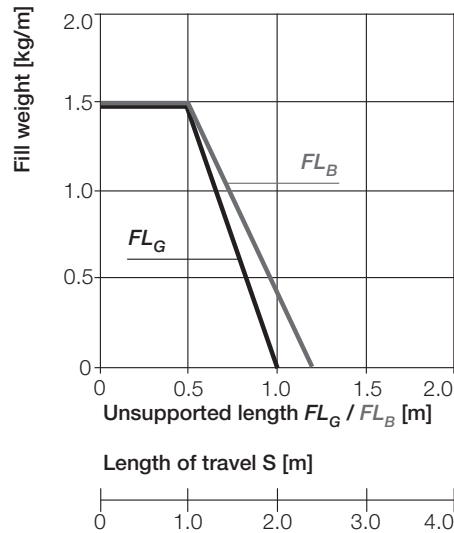
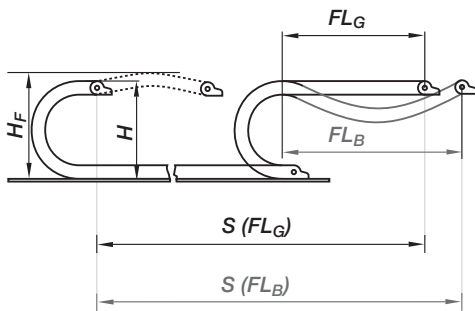

- S = Length of travel
- R = Bending radius
- H = Nominal clearance height
- H_F = Required clearance height
- D = Overlength E-Chain® radius in final position
- $K = \pi \cdot R + \text{"safety"}$

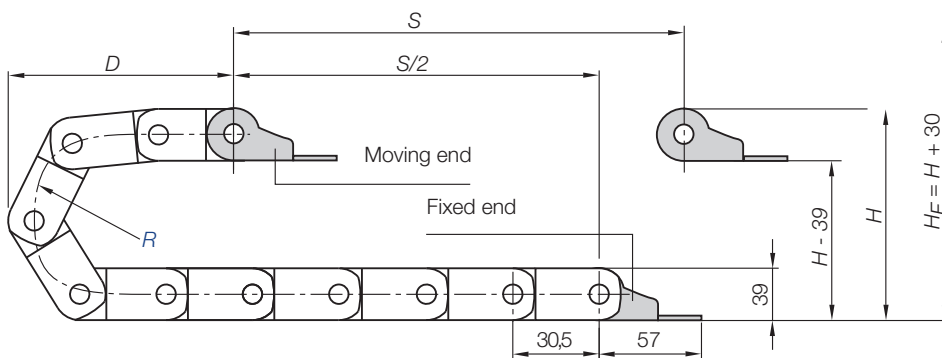

Short travels - unsupported

Unsupported E-Chains® feature positive camber over short travels. This must be accounted for when specifying the clearance height H_F . Please consult igus® if space is particularly restricted.

Pitch = 30,5 mm/link Links/m = 33 (1.006,5 mm) Chain length = $S/2 + K$

| R | 063 | 075 | 100 | 125 |
|---|-----|-----|-----|-----|
| H | 165 | 189 | 239 | 289 |
| D | 115 | 130 | 155 | 180 |
| K | 275 | 305 | 395 | 475 |

The required clearance height:
 $H_F = H + 30 \text{ mm}$
 (with 1,0 kg/m fill weight)

| | |
|--|--|
| Speed / acceleration FL_G | max. 20 [m/s] / max. 200 [m/s ²] |
| Speed / acceleration FL_B | max. 3 [m/s] / max. 6 [m/s ²] |
| Gliding speed / acceleration (maximum) | max. 10 [m/s] / max. 50 [m/s ²] |
| Material - permitted temperature °C | igumid G / -40° to +120° C |
| Flammability class, igumid G | VDE 0304 IIC UL94 HB |

Technical Data



Details of material properties
 ► page 1.38



Zipper E-Tubes
 Inner height: 32 mm

Phone +49- (0) 22 03-96 49-800
 Fax +49- (0) 22 03-96 49-222



► page 4.5

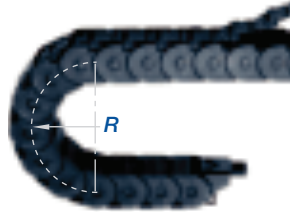
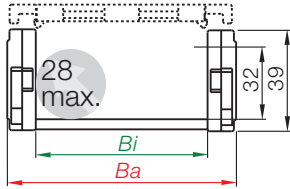

Part No. structure

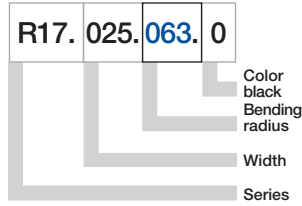

Series R17 E-Chain® - zip-open along outer radius

| Part No. | Bending Radii | | | | Weight [kg/m] |
|-------------|---------------|---------|--------|-------------|---------------|
| | Bi [mm] | Ba [mm] | R [mm] | | |
| R17.015. .0 | 15 | 26 | 063 | 075 100 125 | ≈ 0,52 |
| R17.025. .0 | 25 | 36 | 063 | 075 100 125 | ≈ 0,59 |
| R17.063. .0 | 63 | 76 | 063 | 075 100 125 | ≈ 0,83 |

Supplement part no. with required radius (R) Example: R17.025. 063.0

0 = standard color, other colors ▶ page 1.39 · Pitch = 30,5 mm/link - Links/m = 33



Zipper | **Series R17** | Accessories | Interior Separation

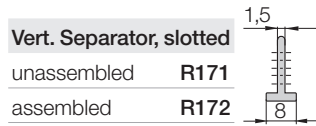

| Vert. Separator, slotted | |
|--------------------------|------|
| unassembled | R171 |
| assembled | R172 |

Option 1: Vertical Separators

- Vertical Separators are used if a vertical subdivision of the E-Chain® interior is required
- Standard subdivision with Vertical Separator, slotted 172, for combinations with Full-Width Shelf 111.X
- By standard Vertical Separators are assembled every other chain link

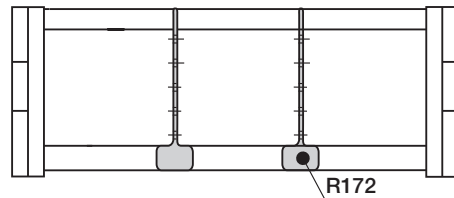

Option 2: Full-Width Shelves

- For applications involving many thin cables with similar or identical diameters.

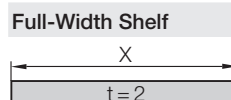
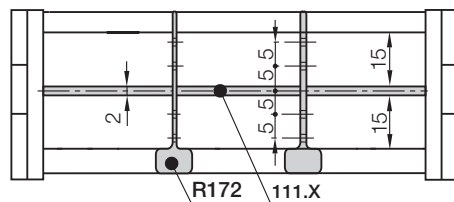

Full-Width Shelf

| Width X [mm] | Part No. | Part No. |
|--------------|-------------|-----------|
| | unassembled | assembled |
| 015 | 110.15 | 111.15 |
| 025 | 110.25 | 111.25 |

| Width X [mm] | Part No. | Part No. |
|--------------|-------------|-----------|
| | unassembled | assembled |
| 063 | 110.63 | 111.63 |



Polymer - locking

- One-piece mounting bracket
- Corrosion-resistant
- Available preassembled
- Inner and outer attachment possible
- Available with or without integrated strain relief tiwrap plates

Moving end with bore
(outer link) 117...1P(Z)

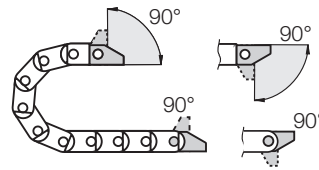

117...2P(Z) Fixed end
with pin (inner link)

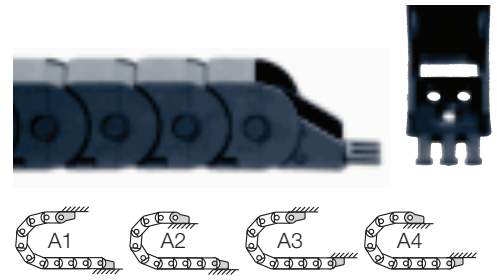

Possible installation conditions for assembled mounting brackets ▶ Order example "preassembled" below

117...1P(Z)
Moving end

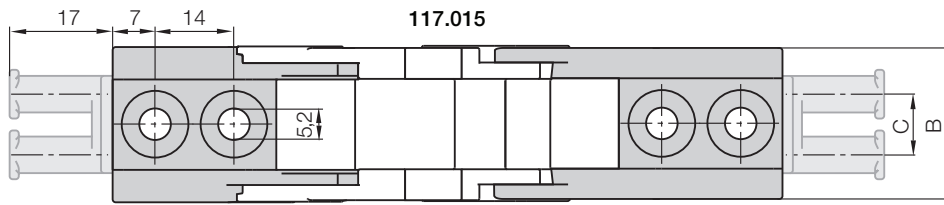

117...2P(Z)
Fixed end

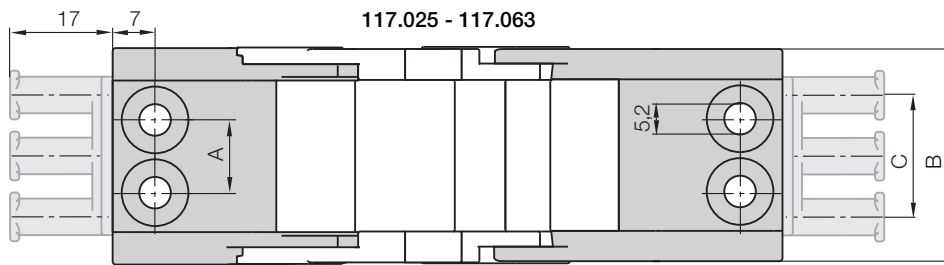

Dimensions and order configurations

Strain relief is possible on the moving end and/or the fixed end.

Part No. structure

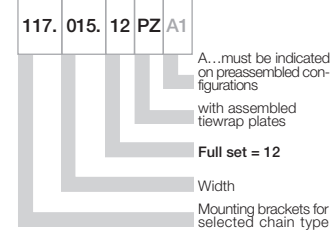

| For E-chain® | Part No. full set with tiwrap plate | Part No. full set without tiwrap plate | Number of teeth | Dim. A [mm] | Dim. B [mm] | Dim. C [mm] |
|--------------|-------------------------------------|--|-----------------|-------------|-------------|-------------|
| R17.015. | ▶ 117.015. 12 PZ | 117.015. 12 P | 2 | - | 25,7 | 10 |
| R17.025. | ▶ 117.025. 12 PZ | 117.025. 12 P | 3 | 12 | 35,7 | 20 |
| R17.063. | ▶ 117.063. 12 PZ | 117.063. 12 P | 6 | 48 | 73,7 | 50 |

Full set, for both ends:

117. 015. 12 PZ +tiwrap plate

Single-part order:

117. 015. 1 PZ +tiwrap plate

Mounting bracket with bore

117. 015. 2 PZ +tiwrap plate

Mounting bracket with pin

For the preassembled mode please add the index A1...A4 Example: 117.015. 12 PZ A1



Quicksnap - the complete, detachable mounting unit, available upon request



Quickfix - mounting bracket with dowel, available upon request

Additional Features

