



iglidur® H – For Wet Environments



Ability to perform underwater

For high temperatures

Resistant to chemicals

Maintenance-free

iglidur® H

Phone +49 - 22 03 - 96 49-145
 Fax +49 - 22 03 - 96 49-334





iglidur® H is a fibre reinforced thermoplastic material that was developed especially for applications in high humidity or underwater. Plain bearings made from iglidur® H can be used completely lubricant free. In wet areas, the surrounding media acts as an additional lubricant.



iglidur® H

2 styles
> 50 dimensions
Ø 3–70 mm



Phone +49 - 22 03 - 96 49-145
Fax +49 - 22 03 - 96 49-334

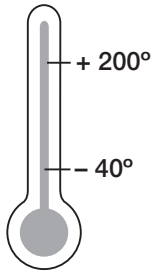

iglus® GmbH
51147 Cologne

Price index



For Wet Environments



When to use iglidur® H plain bearings:

- When high temperature resistance is necessary
- For high mechanical loading
- Suitable for underwater applications
- Maintenance-free
- Resistant to chemicals

When not to use iglidur® H plain bearings:

- When high wear resistance is needed
▶ iglidur® H370 (chapter 15)
- When universal resistance to chemicals is needed
▶ iglidur® X (chapter 6)
- For the maximum pressure at higher temperatures
▶ iglidur® X (chapter 6),
▶ iglidur® Z (chapter 22)

Internet www.igus.de
E-mail info@igus.de



Material Table

General Properties	Unit	iglidur® H	Testing Method
Density	g/cm ³	1,71	
Colour		Grey	
Max. moisture absorption at 23°C / 50% r.F.	% weight	< 0,1	DIN 53495
Max. moisture absorption	% weight	0,3	
Coefficient of friction, dynamic against steel	μ	0,07 - 0,20	
p x v value, max. (dry)	MPa x m/s	1,37	
Mechanical Properties			
Modulus of elasticity	MPa	12.500	DIN 53457
Tensile strength at 20°C	MPa	175	DIN 53452
Compressive strength	MPa	81	
Max. recommended surface pressure (20°C)	MPa	90	
Shore D hardness		87	DIN 53505
Physical and Thermal Properties			
Max. long term application temperature	°C	200	
Max. short term application temperature	°C	240	
Max. short term application temperature	°C	-40	
Thermal conductivity	W/m x K	0,6	ASTM C 177
Coefficient of thermal expansion	K ⁻¹ x 10 ⁻⁵	4	DIN 53752
Electrical Properties¹⁾			
Specific volume resistance	Ωcm	< 10 ⁵	DIN IEC 93
Surface resistance	Ω	< 10 ²	DIN 53482

¹⁾ The good conductivity of this plastic material under certain circumstances can favour the generation of corrosion on the metallic contact component.

Table 12.1: Material Data

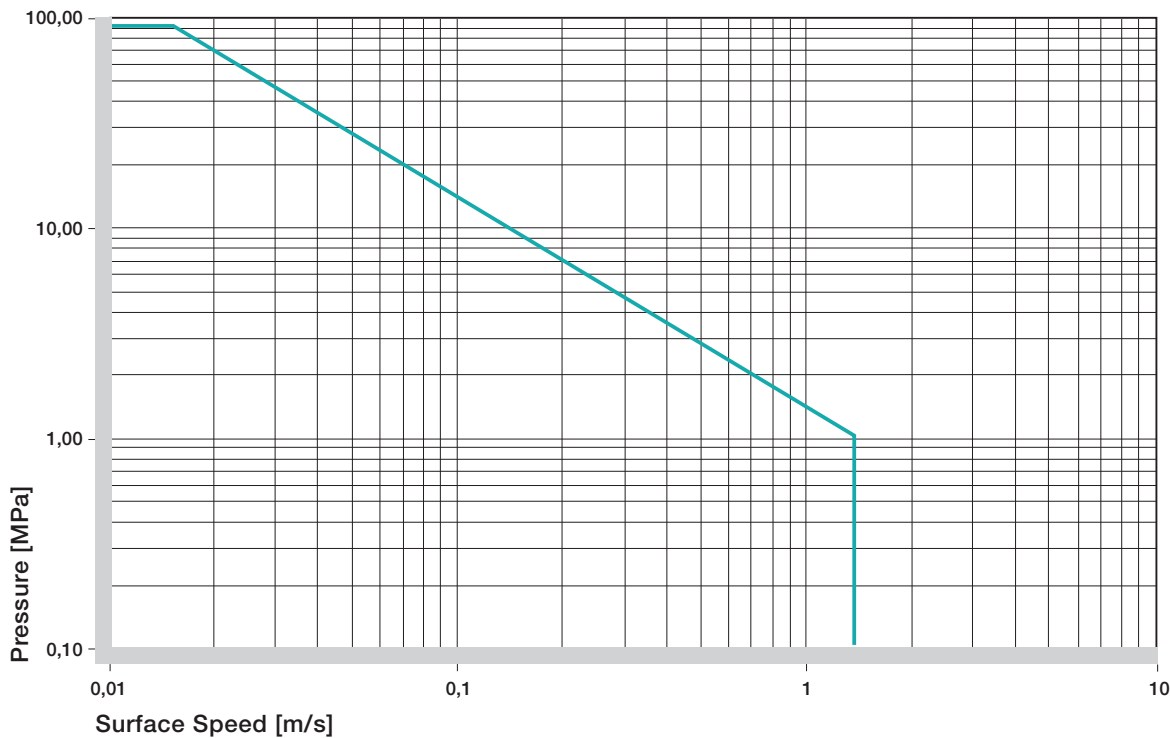

Graph 12.1: Permissible p x v value for iglidur® H running dry against a steel shaft, at 20°C





iglidur® H

Phone +49 - 22 03 - 96 49-145
Fax +49 - 22 03 - 96 49-334

igus® GmbH
51147 Cologne

Internet www.igus.de
E-mail info@igus.de

12.4

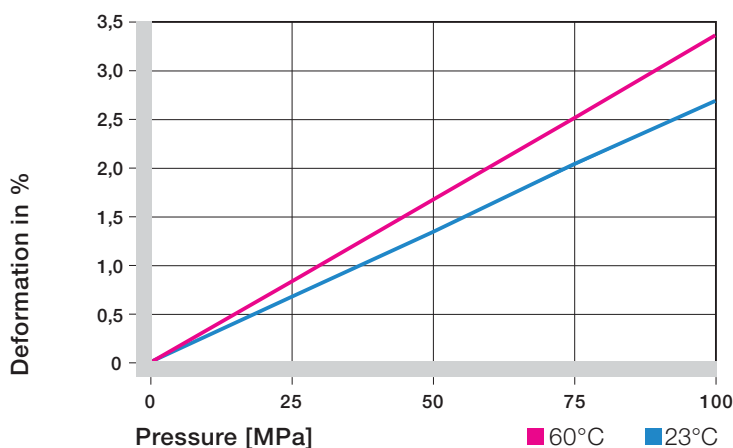

Graph 12.2: Deformation under pressure and temperature

m/s	Rotating	Oscillating	Linear
Continuous	1	0,7	3
Short term	1,5	1,1	4

Table 12.2 : Maximum Surface Speeds

iglidur® H	Application Temperature
Minimum	-40 °C
Max., long term	+200 °C
Max., short term	+240 °C

Table 12.3: Temperature limits for iglidur® H

iglidur® H is a fibre reinforced thermoplastics material that was developed especially for applications in high humidity or underwater. Plain bearings made from iglidur® H can be used completely lubricant-free. In wet areas, the surrounding media acts as an additional lubricant.

Surface Pressure

Graph 12.2 shows the elastic deformation of iglidur® H under exposure to radial loads. At the recommended maximum surface pressure of 90 MPa the deformation is approximately 2.5% at room temperature.

Graph 12.2

Surface Pressure, page 1.18

Permissible Surface Speeds

The maximum permissible running speed depends on whether the temperature at the bearing surface increases too greatly. iglidur® H is suitable for running speeds of 1 m/s (rotating) to 4 m/s (linear). Linear movements allow higher running speeds since a larger area of the shaft contributes to cooling.

Surface Speed, page 1.20

p x v value, page 1.22

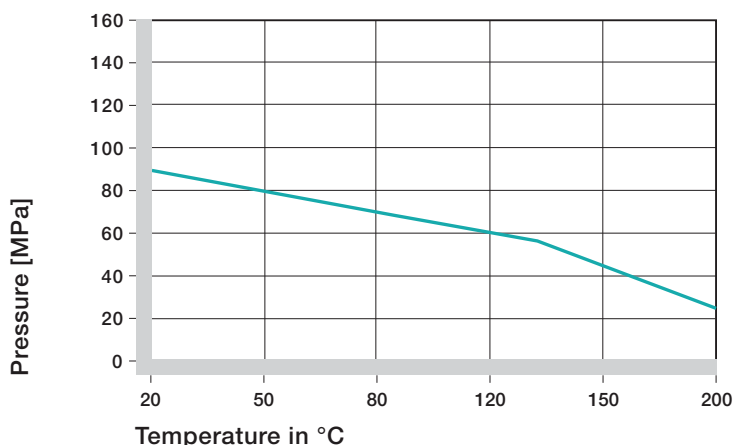

Graph 12.3: Recommended maximum surface pressure of iglidur® H as a function of temperature

Temperatures

iglidur® H is an extremely temperature resistant material. With a maximum permissible short term temperature of 240°C iglidur® H plain bearings may be used in heat treated applications at low loads.

With increasing temperatures, the compressive strength of iglidur® H plain bearings decreases. Graph 12.3 shows this relationship. The ambient temperatures prevalent in the bearing system also have an effect on the bearing wear.

- ☑ Graphs 12.3 and 12.4
- ▶ Application Temperatures, page 1.23

Friction and Wear

Similar to wear resistance, the coefficient of friction μ also changes with the load. Notice that the coefficient of friction μ is slightly reduced with an increase in the surface speed, when the pressure stays the same (see Graphs 12.5 and 12.6).

Since the shaft material also has a large effect on the friction and wear, correct shaft selection is important for iglidur® H. Shafts that are smoother than $R_a = 0.1 \mu\text{m}$ increase the coefficient of friction. For applications with high loads, we recommend hardened and ground surfaces with an average roughness $R_a = 0.3$ to $0.4 \mu\text{m}$.

- ☑ Graphs 12.5 to 12.7
- ▶ Coefficients of Friction and Surfaces, page 1.25
- ▶ Wear Resistance, page 1.26

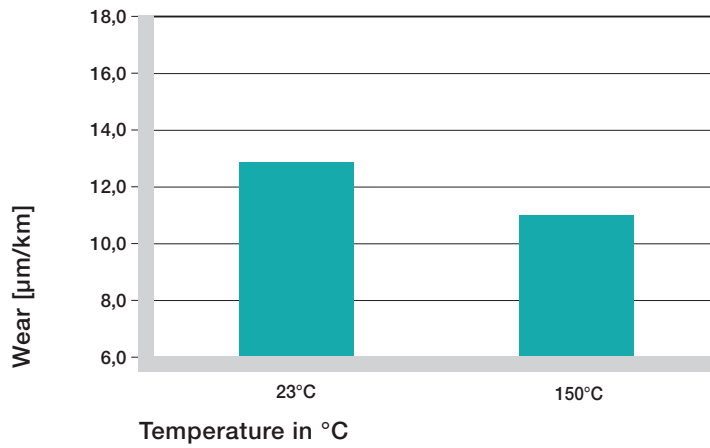

Graph 12.4: Wear as a function of the temperature; rotation with $p = 0.75 \text{ MPa}$ and $v = 0.5 \text{ m/s}$

iglidur® H	Dry	Grease	Oil	Water
C.o.f. [μ]	0,07–0,2	0,09	0,04	0,04

Table 12.4: Coefficients of friction for iglidur® H against steel ($R_a = 1 \mu\text{m}$, 50 HRC)

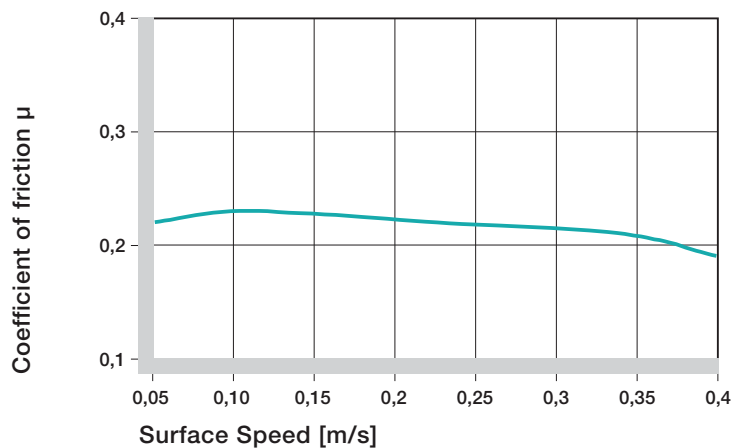

Graph 12.5: Coefficients of friction as a function of the surface speed; $p = 0.75 \text{ MPa}$

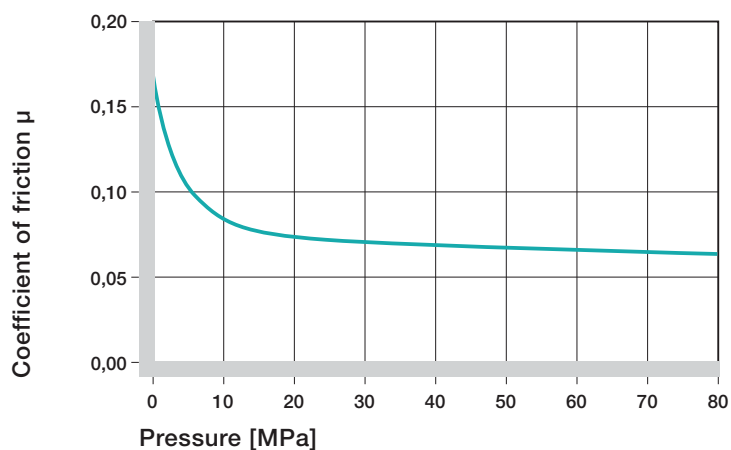

Graph 12.6: Coefficients of friction as a function of the pressure, $v = 0.01 \text{ m/s}$

iglidur® H

Phone +49 - 22 03 - 96 49-145
Fax +49 - 22 03 - 96 49-334

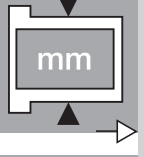
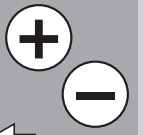



iglidur® H

Phone +49 - 22 03 - 96 49-145
Fax +49 - 22 03 - 96 49-334

igus® GmbH
51147 Cologne

Internet www.igus.de
E-mail info@igus.de

12.6

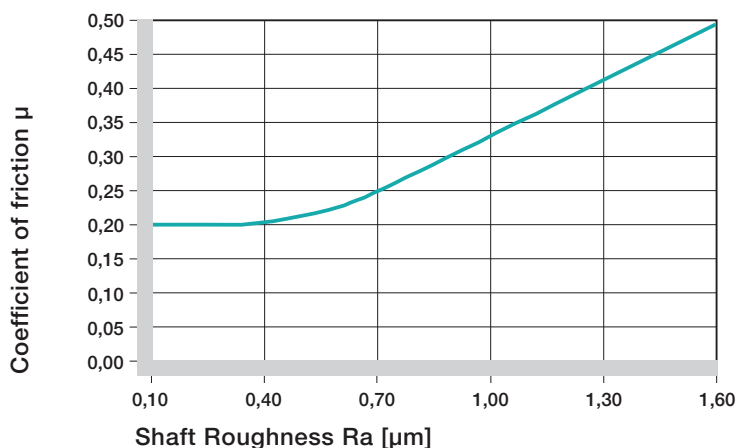

Graph 12.7: Coefficient of friction as a function of the shaft surface

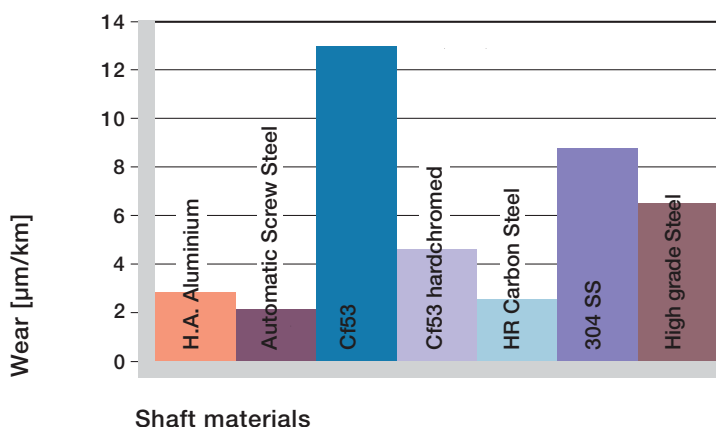

Graph 12.8: Wear of iglidur® H, rotating application with different shaft materials, $p = 0.75 \text{ MPa}$, $v = 0.5 \text{ m/s}$

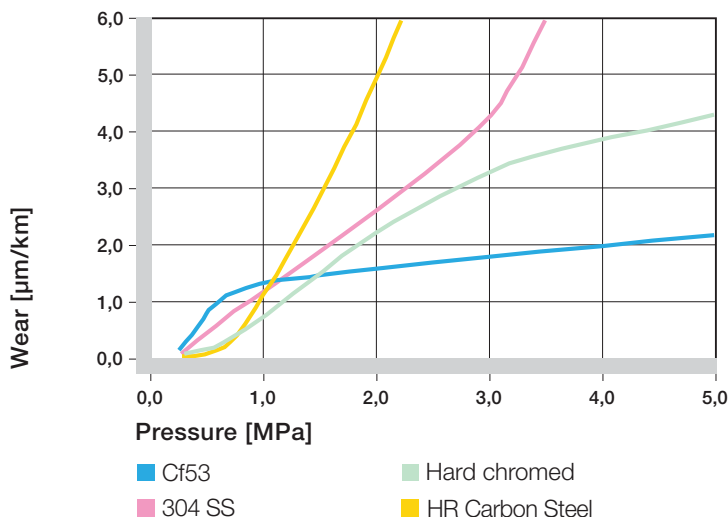

Graph 12.9: Wear of iglidur® H with different shaft materials in rotating applications

Shaft Materials

Graphs 12.8 to 12.10 show results of testing different shaft materials with iglidur® H plain bearings. The results clearly show that in rotating and oscillating applications, the correct shaft selection is critical.

Whereas for rotating applications, shafts made of Cf53 hardened and ground steel and HR Carbon Steel show the best wear values, the 303 Stainless Steel shaft is best suited for oscillating movements. Also, hard chromed shafts with iglidur® H bearings are only recommended for very low loads.

If the shaft material you plan to use is not contained in this list, please contact us.

Graphs 12.8 to 12.10

Shaft Materials, pages 1.28

Installation Tolerances

iglidur® H plain bearings are meant to be oversized before pressfit. The bearings are designed for pressfit into a housing machined to a H7 tolerance. After being assembled into a nominal size housing, the inner diameter adjusts to meet our specified tolerances. Please adhere to the catalogue specifications for housing bore and recommended shaft sizes. This will help to ensure optimal performance of iglidur® H plain bearings.

Testing Methods, page 1.35

Chemical Resistance

iglidur® H plain bearings have a good resistance to chemicals. Thus, even aggressive chemicals can act as lubricants. Plain bearings made of iglidur® H are not resistant to hot, oxidizing acids.

The moisture absorption of iglidur® H plain bearings is below 0.1% in standard atmosphere. The saturation limit in water is 0.3%. iglidur® H does not swell and thus is very well suited for use in wet surroundings.

► Chemical Table, pages 70.1

Radiation Resistance

iglidur® H withstands both neutron as well as gamma particle radiation up to an intensity of 2×10^2 Gy.

UV Resistance

iglidur® H plain bearings are only conditionally resistant against UV radiation. Under the effects of weathering, the surface of iglidur® H becomes rougher, and the compressive strength of the material decreases.

Vacuum

For use in a vacuum environment, it must be taken into account that a small amount of moisture is released as vapour.

Electrical Properties

iglidur® H plain bearings are electrically conductive.

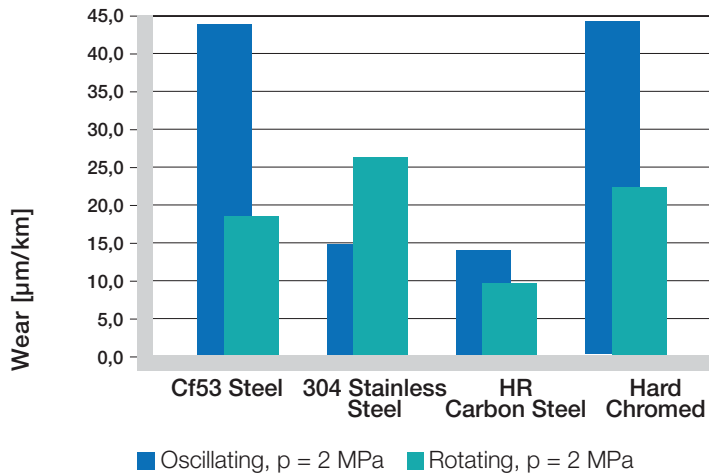

Graph 12.10: Wear of iglidur® H for oscillating and rotating applications with different shaft materials

Diameter d1 [mm]	Shaft h9 [mm]	iglidur® H F10 [mm]
up to 3	0-0,025	+0,006 +0,046
> 3 to 6	0-0,030	+0,010 +0,058
> 6 to 10	0-0,036	+0,013 +0,071
> 10 to 18	0-0,043	+0,016 +0,086
> 18 to 30	0-0,052	+0,020 +0,104
> 30 to 50	0-0,062	+0,025 +0,125
> 50 to 80	0-0,074	+0,030 +0,150

Table 12.5: Essential tolerances for iglidur® H plain bearings according to ISO 3547-1 after pressfit

Medium	Resistance
Alcohol	+
Hydrocarbons	+
Greases, oils without additives	+
Fuels	+
Diluted acids	+ to 0
Strong acids	+ to -
Diluted alkalines	+
Strong alkalines	+

Table 12.6: Chemical resistance of iglidur® H – detailed list, page 70.1

+ resistant 0 conditionally resistant - not resistant

All data given at room temperature [20°C]

iglidur® H	
Specific	
volume resistance	> 10 ⁵ Ωcm
Surface resistance	> 10 ² Ω

Table 12.7: Electrical properties of iglidur® H

iglidur® H

Phone +49 - 22 03 - 96 49-145
Fax +49 - 22 03 - 96 49-334



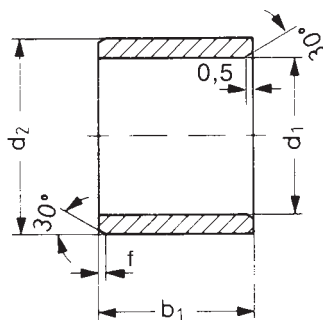

Data in mm

Structure - part no.
H S M-0304-03



Chamfer in relation to the d1

d1 [mm]:	Ø 1-6	Ø 6-12	Ø 12-30	Ø > 30
f [mm]:	0,3	0,5	0,8	1,2

Dimensions according to ISO 3547-1 and special dimensions

Part Number	d1	d1 Tolerance*	d2	b1 h13	Part Number	d1	d1 Tolerance*	d2	b1 h13
HSM-0304-03	3,0	+0,006 +0,046	4,5	3,0	HSM-1820-15	18,0	+0,016 +0,086	20,0	15,0
HSM-0405-04	4,0	+0,010 +0,058	5,5	4,0	HSM-1820-25	18,0	+0,016 +0,086	20,0	25,0
HSM-0507-05	5,0	+0,010 +0,058	7,0	5,0	HSM-2023-20	20,0	+0,020 +0,104	23,0	20,0
HSM-0608-03	6,0	+0,010 +0,058	8,0	3,0	HSM-2225-20	22,0	+0,020 +0,104	25,0	20,0
HSM-0608-06	6,0	+0,010 +0,058	8,0	6,0	HSM-2528-15	25,0	+0,020 +0,104	28,0	15,0
HSM-0810-08	8,0	+0,013 +0,071	10,0	8,0	HSM-2528-20	25,0	+0,020 +0,104	28,0	20,0
HSM-0810-10	8,0	+0,013 +0,071	10,0	10,0	HSM-3034-20	30,0	+0,020 +0,104	34,0	20,0
HSM-1012-06	10,0	+0,013 +0,071	12,0	6,0	HSM-3034-30	30,0	+0,020 +0,104	34,0	30,0
HSM-1012-10	10,0	+0,013 +0,071	12,0	10,0	HSM-3034-40	30,0	+0,020 +0,104	34,0	40,0
HSM-1214-10	12,0	+0,016 +0,086	14,0	10,0	HSM-3236-30	32,0	+0,025 +0,125	36,0	30,0
HSM-1214-12	12,0	+0,016 +0,086	14,0	12,0	HSM-3539-40	35,0	+0,025 +0,125	39,0	40,0
HSM-1214-15	12,0	+0,016 +0,086	14,0	15,0	HSM-4044-20	40,0	+0,025 +0,125	44,0	20,0
HSM-1214-20	12,0	+0,016 +0,086	14,0	20,0	HSM-4044-50	40,0	+0,025 +0,125	44,0	50,0
HSM-1416-20	14,0	+0,016 +0,086	16,0	20,0	HSM-4550-30	45,0	+0,025 +0,125	50,0	30,0
HSM-1517-15	15,0	+0,016 +0,086	17,0	15,0	HSM-5055-40	50,0	+0,025 +0,125	55,0	40,0
HSM-1618-15	16,0	+0,016 +0,086	18,0	15,0	HSM-5560-26	55,0	+0,030 +0,150	60,0	26,0
HSM-1618-20	16,0	+0,016 +0,086	18,0	20,0	HSM-6065-60	60,0	+0,030 +0,150	65,0	60,0
HSM-1618-25	16,0	+0,016 +0,086	18,0	25,0	HSM-7075-50	70,0	+0,030 +0,150	75,0	50,0

*after pressfit. Testing methods ► page 1.35

Order example

Our price breaks are defined by the order quantity.

1- 9	25-49	100-199	500- 999	2500-4999
10-24	50-99	200-499	1000-2499	

For the current prices please visit the iglus®-Homepage www.igus.de/en

No minimum order quantities, no surcharges.



Type S

Type F

Lifetime calculation, CAD files and much more support ► www.igus.de/en/h

Phone +49 - 22 03 - 96 49-145
Fax +49 - 22 03 - 96 49-334

iglus® GmbH
51147 Cologne

Internet www.igus.de
E-mail info@igus.de

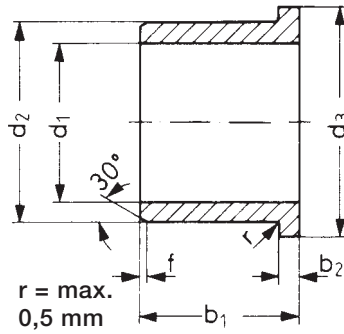

Data in mm

Structure – part no.
H F M-0405-04

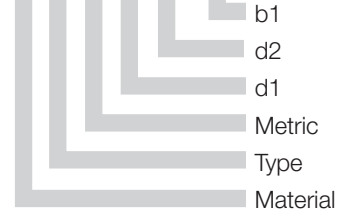

Dimensions according to ISO 3547-1
and special dimensions

Chamfer in relation to the d1

d1 [mm]:	Ø 1-6	Ø 6-12	Ø 12-30	Ø > 30
f [mm]:	0,3	0,5	0,8	1,2

Part Number	d1	d1 Tolerance*	d2	d3	b1	b2
HFM-0405-04	4,0	+0,010 +0,058	5,5	9,5	4,0	0,75
HFM-0507-05	5,0	+0,010 +0,058	7,0	11,0	5,0	1,0
HFM-0507-08	5,0	+0,010 +0,058	7,0	11,0	8,0	1,0
HFM-0608-04	6,0	+0,010 +0,058	8,0	12,0	4,0	1,0
HFM-0608-06	6,0	+0,010 +0,058	8,0	12,0	6,0	1,0
HFM-0810-07	8,0	+0,013 +0,071	10,0	15,0	7,0	1,0
HFM-0810-10	8,0	+0,013 +0,071	10,0	15,0	10,0	1,0
HFM-0810-15	8,0	+0,013 +0,071	10,0	15,0	15,0	1,0
HFM-1012-04	10,0	+0,013 +0,071	12,0	18,0	4,0	1,0
HFM-1012-09	10,0	+0,013 +0,071	12,0	18,0	9,0	1,0
HFM-1012-15	10,0	+0,013 +0,071	12,0	18,0	15,0	1,0
HFM-1012-20	10,0	+0,013 +0,071	12,0	18,0	20,0	1,0
HFM-1214-07	12,0	+0,016 +0,086	14,0	20,0	7,0	1,0
HFM-1214-10	12,0	+0,016 +0,086	14,0	20,0	10,0	1,0
HFM-1214-15	12,0	+0,016 +0,086	14,0	20,0	15,0	1,0
HFM-1416-12	14,0	+0,016 +0,086	16,0	22,0	12,0	1,0
HFM-1517-17	15,0	+0,016 +0,086	17,0	23,0	17,0	1,0
HFM-1618-17	16,0	+0,016 +0,086	18,0	24,0	17,0	1,0
HFM-1820-17	18,0	+0,016 +0,086	20,0	26,0	17,0	1,0
HFM-2023-16	20,0	+0,020 +0,104	23,0	30,0	16,5	1,5
HFM-2023-30	20,0	+0,020 +0,104	23,0	30,0	30,0	1,5
HFM-2528-30	25,0	+0,020 +0,104	28,0	35,0	30,0	1,5
HFM-2730-20	27,0	+0,020 +0,104	30,0	38,0	20,0	1,5
HFM-3034-40	30,0	+0,020 +0,104	34,0	42,0	40,0	2,0
HFM-3438-13	34,0	+0,025 +0,125	38,0	46,0	13,0	2,0
HFM-3539-26	35,0	+0,025 +0,125	39,0	47,0	26,0	2,0
HFM-4044-40	40,0	+0,025 +0,125	44,0	52,0	40,0	2,0
HFM-5055-50	50,0	+0,025 +0,125	55,0	63,0	50,0	2,0
HFM-6065-50	60,0	+0,030 +0,150	65,0	73,0	50,0	2,0
HFM-7075-50	70,0	+0,030 +0,150	75,0	83,0	50,0	2,0

*after pressfit. Testing methods ► page 1.35

iglidur® H – Type F

mm

Phone +49 - 22 03 - 96 49-145
Fax +49 - 22 03 - 96 49-334

