

INDUSTRY

FORUM

20 & 21 MARCH 2019

2019

20 years of eCATALOG

20 Powerful Ideas to take your Business
to the Next Level



Wolfgang Nagl
Key Account Manager



Sascha Heinemann
Branch Manager



(CADENAS =
span. chains)

Founded 1992

Headquarter Augsburg, Germany

Employees > 320 worldwide

Branches growth > 20 %
~ 900 000 licenses and
> 800 catalogs



💡 About this presentation

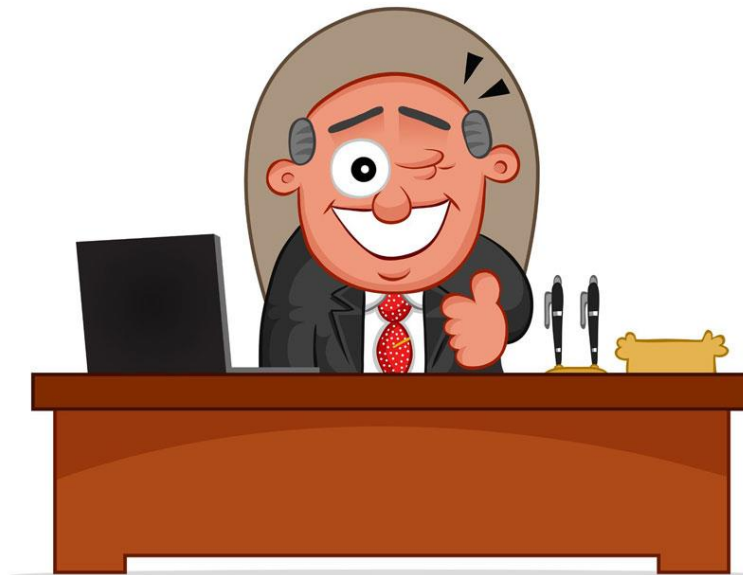



⊘ STEP files exist on the homepage

⊘ Nur STEP Daten wie bisher



✓ Mit eCATALOGsolutions ins CAD eingebettetes STEP 3D = Multi CAD



⊘ protect company secrets

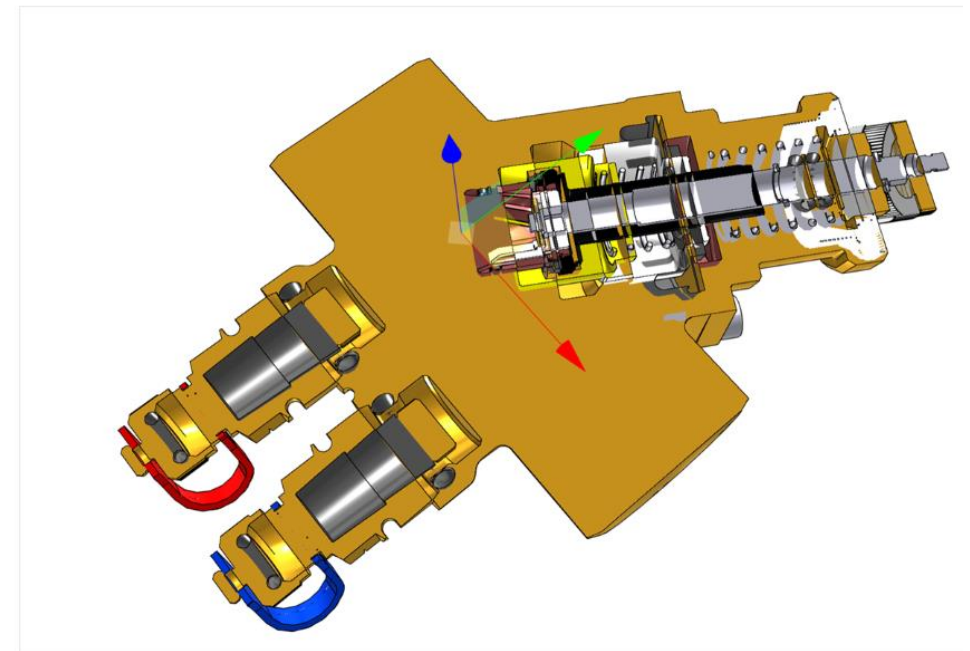
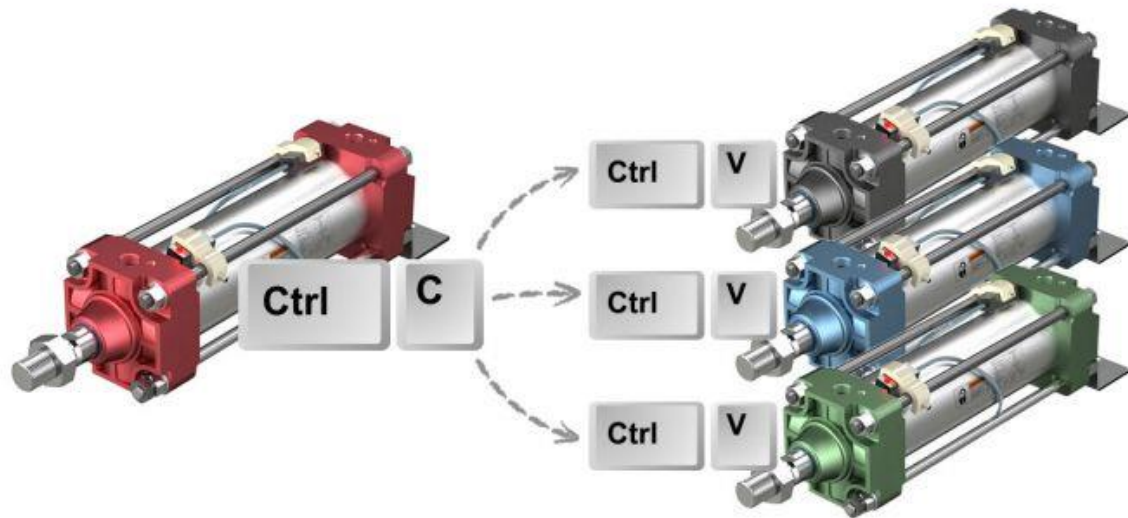

<https://www.cadenas.de/de/produkte/ecatalogsolutions/quick-and-simple/schutz-von-firmengeheimnissen>
<https://www.cadenas.de/news/de/reader/items/ist-ihr-geistiges-eigentum-vor-produktpiraterie-geschuetzt>

⊘ too simplified for your clients?

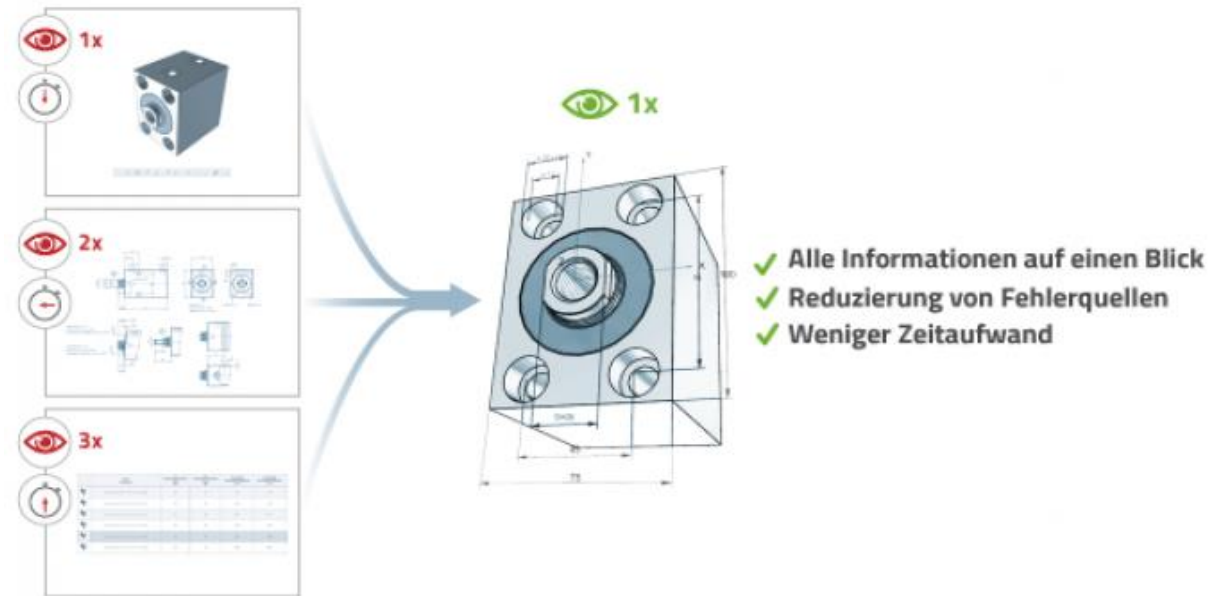

⊘ Your customers want design?

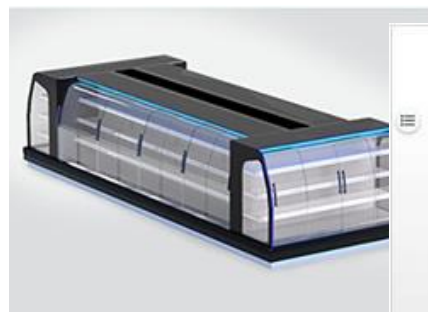
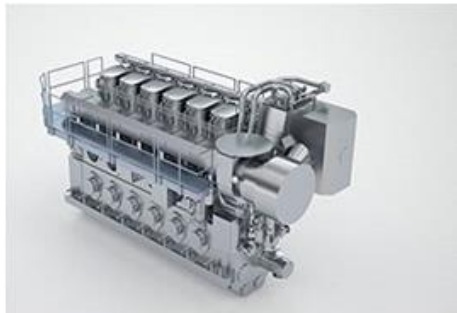

⊘ 3D instead of 2D

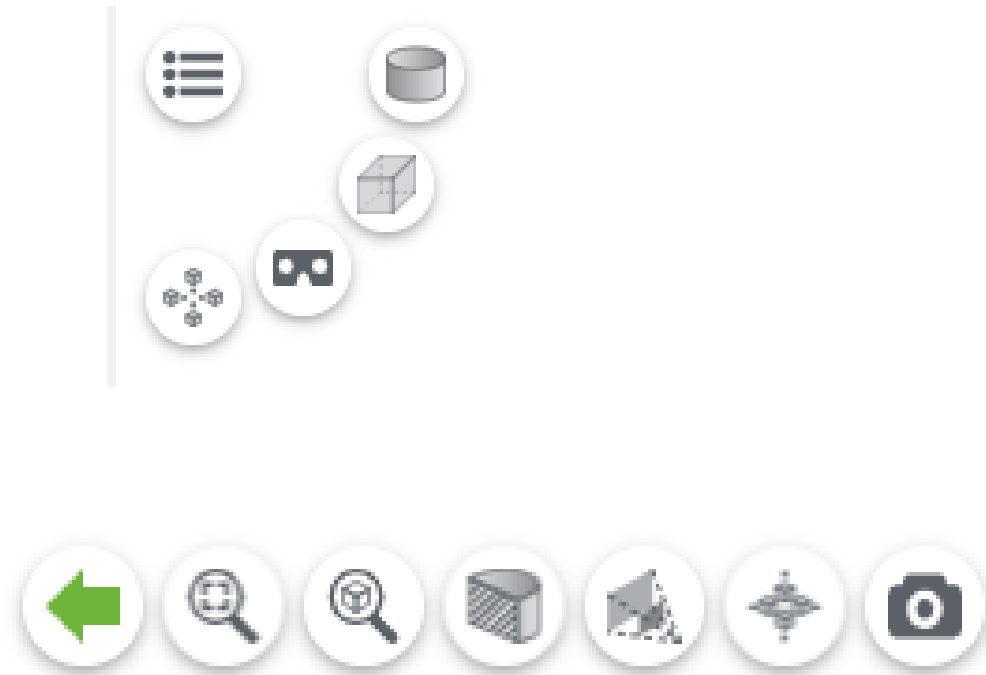
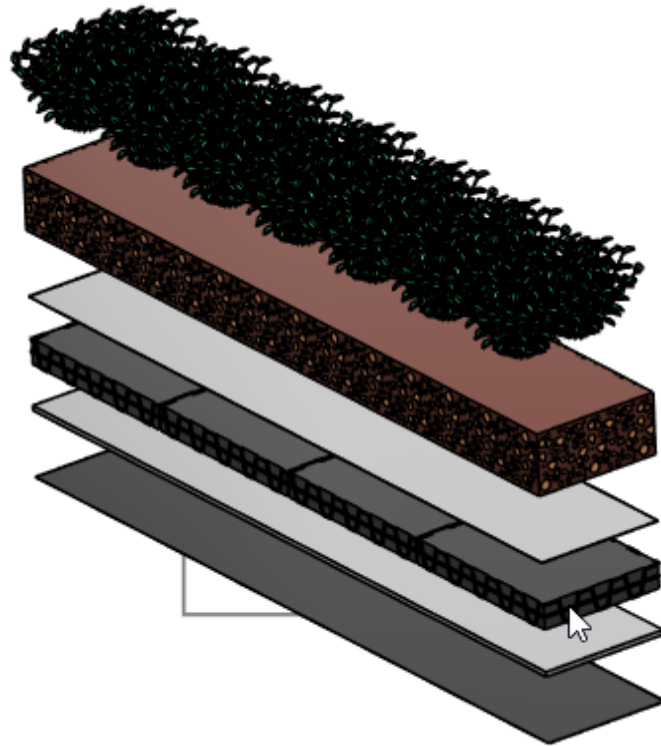

https://zinco.partcommunity.com/3d-cad-models/sedumteppich-zinco?info=zinco%2Fsysteme_gruendach%2Fextensive_dachbegruenung%2Fsedumteppich_asmtab.prj

🚫 you are invisible in the web?

Virtual Reality (VR)



Holografie



Augmented Reality (AR)



Anaglyph 3D



🚫 reach out ot business users?



🚫 get contact details

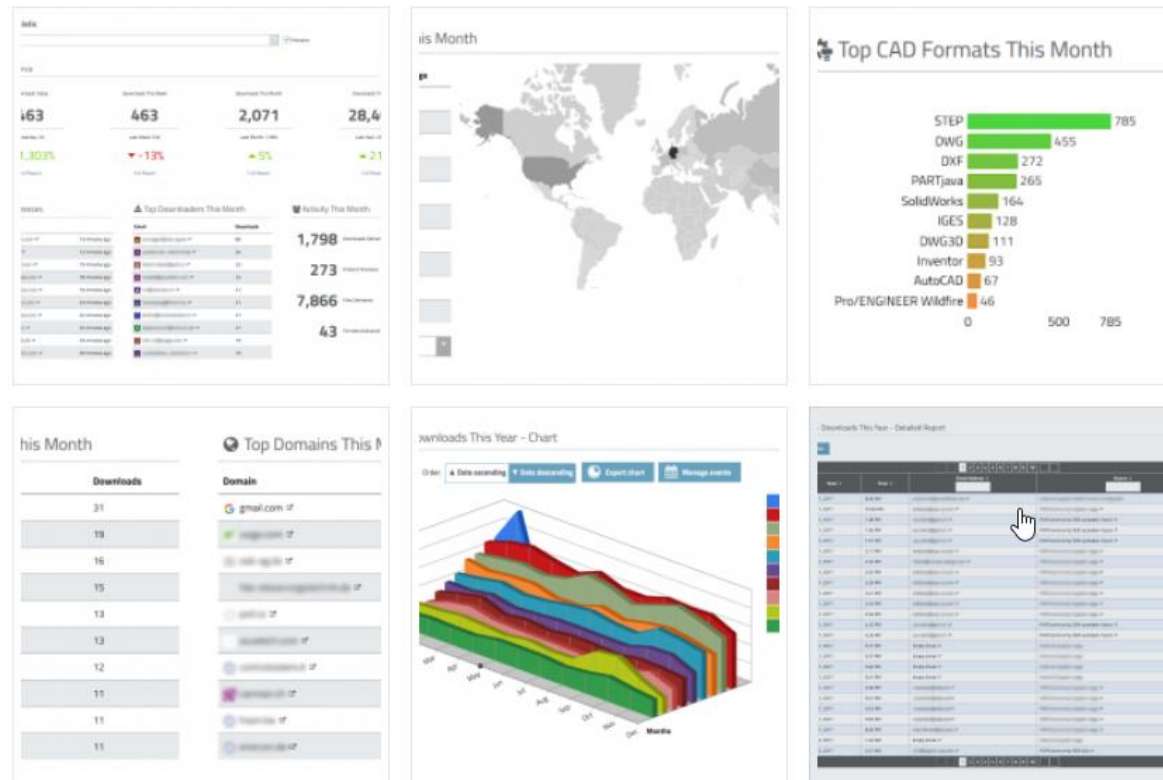

<https://www.cadenas.de/de/produkte/ecatalogsolutions/innovative-marketingstrategien/statistiken-analysen>

⊘ reach exotic countries



| | | | | | |
|-----|----------------------|------------------|----------|-------|-----|
| 170 | Turkmenistan | | | | |
| 171 | Rwanda | Fri Feb 8, 2019 | 10:05:14 | 0.00% | 394 |
| 172 | Papua New Guinea | Thu Feb 7, 2019 | 05:20:16 | 0.00% | 390 |
| 173 | Faroe Islands | Tue Feb 5, 2019 | 01:46:00 | 0.00% | 373 |
| 174 | Virgin Islands, U.S. | Mon Jan 14, 2019 | 20:49:02 | 0.00% | 326 |
| 175 | Malawi | Wed Feb 6, 2019 | 15:44:31 | 0.00% | 311 |

<https://www.cadenas.de/de/produkte/ecatalogsolutions/innovative-marketingstrategien/statistiken-analysen>

⊘ multi lingual



no multi lingual

✔ Neben 3D STEP Daten werden auch Sprachen in die CAD Datei eingebettet



Ihre STEP Datei

eCATALOGsolutions

Mehrsprachigkeit



⊘ Is the effort worth it?

77-85%
of sales leads
are getting purchased!

🚫 You don't believe the numbers?

"With our electronic product catalog and the 3D CAD download portal we offer our customers the best service. Since the cooperation with CADENAS, our turnover has increased significantly "

Simon Roth
KETTEN FUCHS GmbH



PARTcommunity liefert uns qualitativ hochwertige Leads. Ca. 80 % der Anfragen können zu Kunden gemacht werden.

Paolo Fioroni
UNIVER S.p.A.



💡 How did they do it?

Find & choose

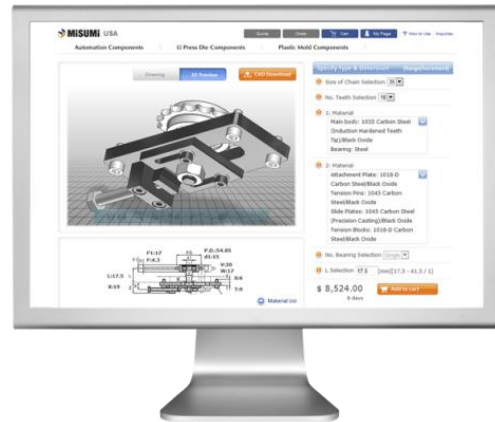

Download
development and CAD

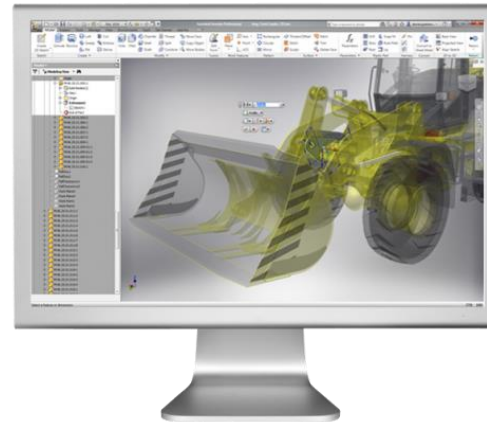

⊘ So many leads so little time

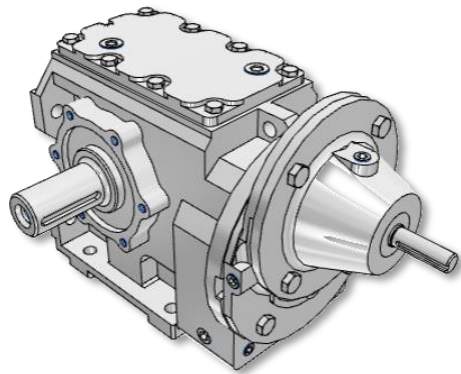

Central management
of your product data



Data access &
interfaces

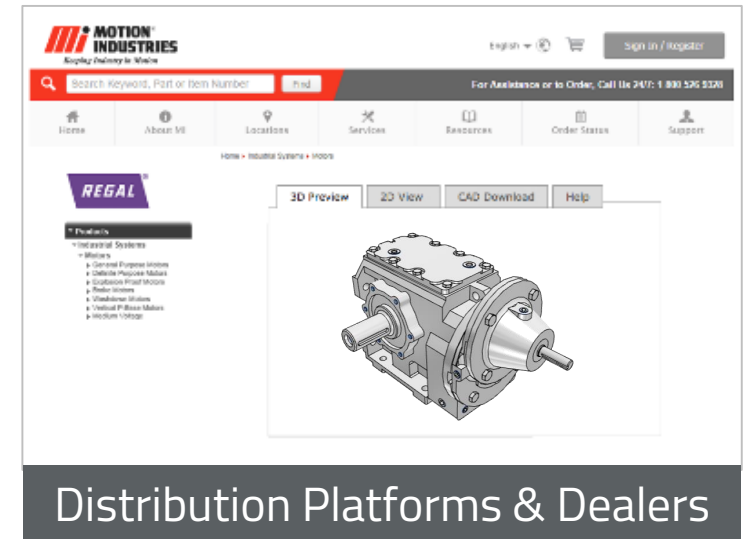

⊘ Nothing is worse than old data

» Aus Gründen der Wiederbeschaffung ist es für uns äußerst wichtig, dass bei Produkten End of Life Informationen hinterlegt sind. Bei der Konstruktion muss ich die Lebensdauer unserer Anlagen berücksichtigen und möchte deshalb Planungssicherheit bezüglich der Ersatzteile haben. Wenn ich weiß, dass eine Komponente noch mindestens zehn Jahre verfügbar sein wird, bevorzuge ich dieses Produkt. «



ANDREAS DÄTWYLER
SENIOR DESIGN ENGINEER
II-VI LASER ENTERPRISE GMBH



| DIN 914 | ISO 1207 |
|--|--|
| Zylinderschrauben mit Schlitz | Zylinderschrauben mit Schlitz |
| 30.04.14 mm | 08.05.14 mm |
| DIN 914 | ISO 1207 |
| Bezeichnung: Zylinderschrauben mit Schlitz | Bezeichnung: Zylinderschrauben mit Schlitz |
| Einheit: mm | Einheit: mm |
| Letzte Änderung: 30.04.2014 13:10:49 | Letzte Änderung: 08.05.2014 14:30:54 |
| Abtaefaktor: 01.05.2014 02:00:00 | |

🚫 How exactly does the user access the products?



Exchange model for contact details

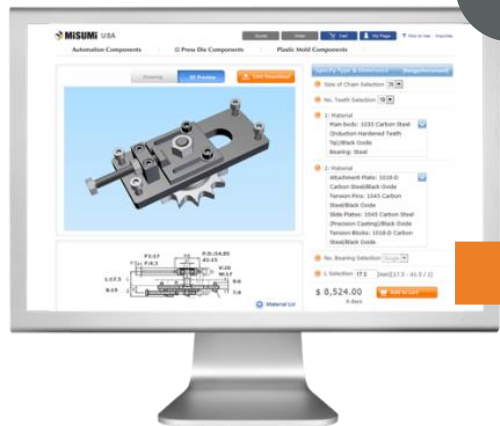

user searches product

1

Name:

Company:

Email:

SUBMIT

Submit information for downloading CAD

2

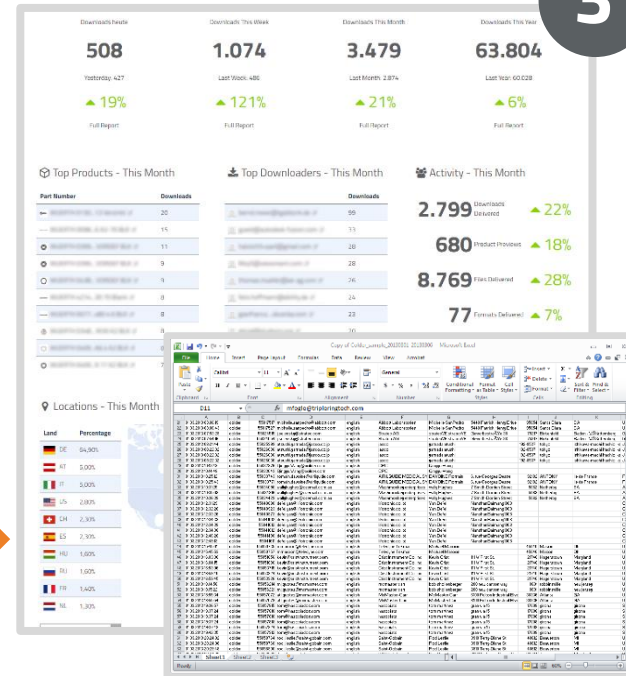

You get leads & data

3



Marketing



Sales



Distributors



Analysis

⊘ Do not draw the attention of existing customers to competition

HEB Hydraulik-Elementebau GmbH

Home | Kontakt | Ihre Anfrageliste

HEB > Produkte > Blockzylinder > BLZNI400

HEB Hydraulik - Blockzylinder BLZNI400

mit integrierten Näherungsschaltern

Typ: Block-Zylinder Weitere Einzelheiten entnehmen Sie bitte dem > HEB BLZ400|BLZNI400

Nenndruck: 400 bar

Prüfdruck: 600 bar

Max. Hub: 500 mm

KolbenØ: 16 bis 100 mm

Endlagenabfrage: ja

Einsatzgebiet: Formenbau
Werkzeugbau
Vorrichtungsbau

Ihren Zylinder konfigurieren

BLZNI400-1-32/20/15-205/M1

| | | | |
|--|---|-----|-----|
| NENNDRUCK Nenndruck | 0 | 400 | bar |
| BA Bauform | 1 - 2 Querbohrungen, ab 160 bar Abstützung erforderlich | | |
| KOLBEN Kolben - Ø | 32 | | mm |
| D2 Kolbenstangen - Ø | 20 | | mm |
| HUB Hub | 5 | 15 | mm |
| HUBWAHL Standard/Sonder/Hubbegrenzung | Standardhub | | |

3D 2D

<https://www.heb-zyl.com/hydraulik/blockzylinder/blockzylinder-blzni400.html>

⊘ How to integrate 3D into eCommerce?

The screenshot shows the IMI Precision Engineering website interface. At the top, there is a navigation bar with links for Home, Products, Expertise, Technical Support, Help, Distributors, and About. A search bar and a basket icon (0 items) are also present. The main content area features a 3D CAD model of a mechanical component with dimensions: 54, 44, 54, 300, 235, and 54. To the right of the model is a configuration panel titled "Your configuration:" with the following details:

| | |
|--------------------|-----------------|
| PDA/802125/M/75 | \$456.08 |
| Total price | \$456.08 |
| Dispatch Date: | 5 days |

Below the configuration panel, there is a quantity selector set to "1" and an "Add To Basket" button. A link for "Product Datasheet (PDF)" is also visible. At the bottom of the page, there are icons for various 3D viewing options and a footer indicating the site is powered by CADENAS, with links to legal notices and privacy policies.

<https://www.imi-precision.com/us/en/Configure.aspx?pn=PDA/802125/M/75>

🚫 It's on the web, where is the App?

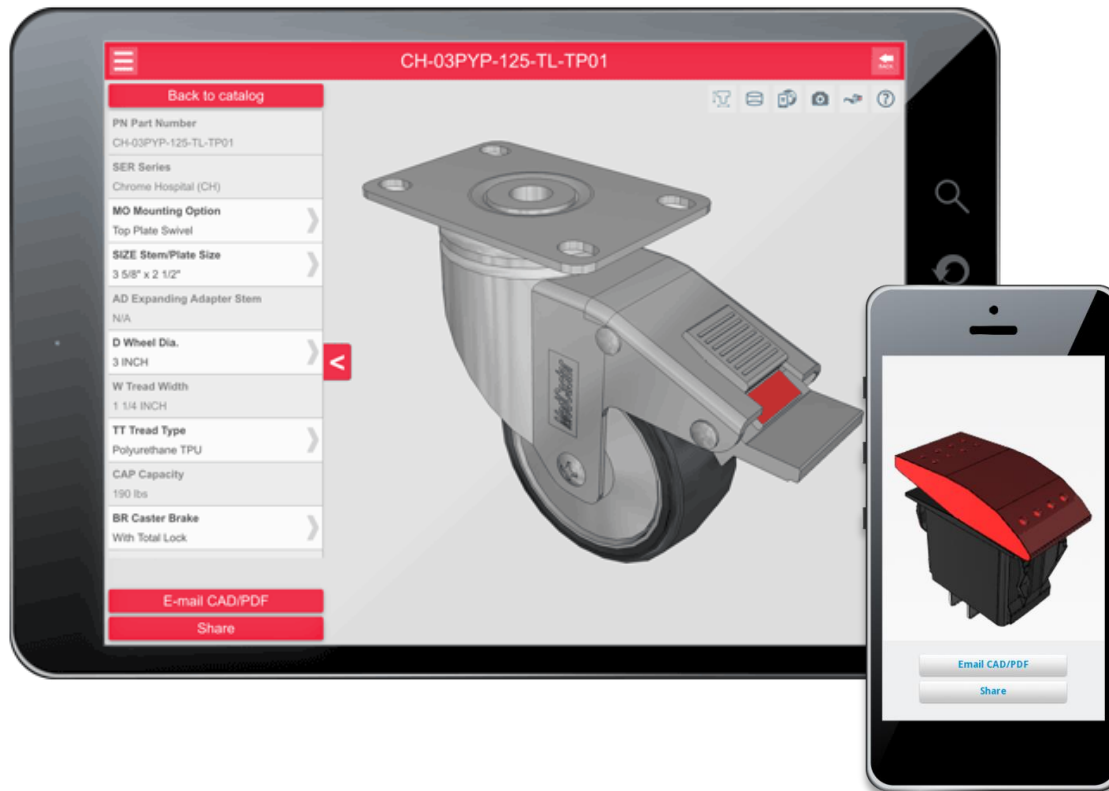

- ✓ Always the complete catalog at hand
- ✓ Configurable components
- ✓ Interactive 3D preview
- ✓ Email and Share features



⊘ Are the costs in proportion to the benefits?

Messe

vs.

PARTcommunity

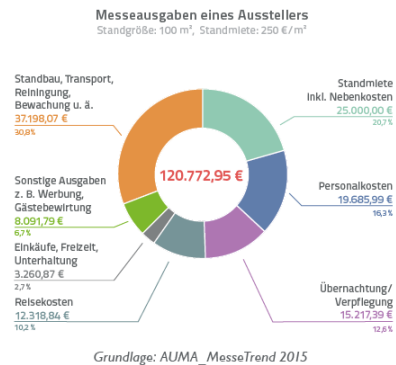

Kalkuliert mit Durchschnittswerten
exklusive einmalige Investitionskosten



300 Leads / Messe
(inkl. Studenten, fachfremde Besucher etc.)



402,58 € / Lead

2.658 Downloads / Monat
(Ingenieure, Konstrukteure, CAD Anwender, Einkäufer etc.)



4,13 € / Lead

The cost of a trade show stand at approx. € 8,000,- for a 6x6m booth. Plus staff cost even to a total of € 25,000, - per exhibit

source: <http://www.exhibitsusa.com/average-costs-to-display-attend-trade-shows>

🚫 Invest in a startup?



CADENAS vereint

Hersteller & Lieferanten
von Komponenten
mit der Industrie!

eCATALOG solutions

CADENAS Lösungen für
Hersteller & Lieferanten von Komponenten

Der Elektronische Produktkatalog



Die Softwarelösung zur Erstellung und Vermarktung von Elektronischen CAD Produktkatalogen.

Die intelligenten CAD Modelle



Weit mehr als Geometrie: Optimale Produkt- und Engineeringdaten mit maximalem Komfort & Funktionalität.

Die Smart Sales Lösung



Wissen, wer und wo Ihre Kunden sind: Produkte zur richtigen Zeit, am richtigen Ort, der richtigen Person anbieten.

Die Vertikalen Marktplätze



Zahlreiche Online-Marktplätze mit Millionen von Nutzern als Multiplikator für Ihren Elektronischen CAD Produktkatalog.

BIMcatalogs.net



Technologie und Know-how des Elektronischen Produktkatalogs für den Architekturbereich.

PART solutions

CADENAS Lösungen für
industrielle Abnehmer von Komponenten

Das Strategische Teilemanagement

Nachhaltige Kostenreduzierung bei Norm-, Kauf- und Eigenteilen im Engineering und Einkauf.



Die Geometrische Ähnlichkeitssuche

Vorhandene CAD Geometrien intelligent finden und semiautomatisch klassifizieren.



Das Lieferantenportal

Plattform zur optimierten Kommunikation mit externen Dienstleistern im Bereich Entwicklung.



Das PURCHINEERING Konzept

Optimierte Zusammenarbeit zwischen Einkauf und Engineering.



Vielen Dank für Ihre Aufmerksamkeit

Fragen?

Feedback?

Wolfgang Nagl, Key Account Manager
Sascha Heinemann, Branch Manager

Phone.:

+49 821 / 2 58 58 0 - 0

E-Mail:

w.nagl@cadenas.de

sa.heinemann@cadenas.de