

Rigid Shaft Coupling

optional
nickel-plated version
optional full stainless
steel version

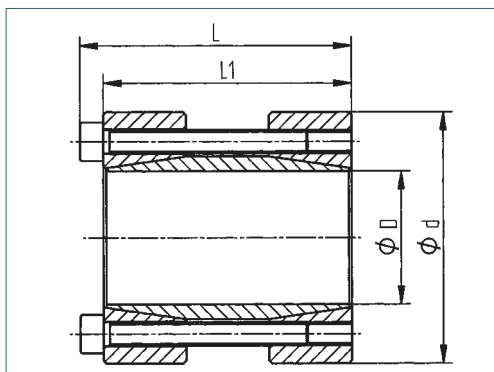

transmittable torque	high
self-centering	yes
axial movement of the hub during assembly	no
height D/d	medium
overall length	medium

Order Code

KBS 95 - 20 x 50

Type

Ød

ØD

Recommended finishing tolerances of contact surfaces are: shaft h8 / hub H8

Inner / Outer Ø dxD	Torque T Nm	Dimensions		Screws			Mass kg
		L mm	L1 mm	No.	ISO 4762	TA Nm	
15 x 45	158	56	50	4	M6x40	17	0.41
16 x 50	168	56	50	4	M6x40	17	0.49
17 x 50	200	56	50	4	M6x40	17	0.49
18 x 50	220	56	50	4	M6x40	17	0.48
19 x 50	230	56	50	4	M6x40	17	0.46
20 x 50	240	56	50	4	M6x40	17	0.44
24 x 55	290	66	60	4	M6x40	17	0.64
25 x 55	450	66	60	6	M6x50	17	0.65
28 x 60	510	66	60	6	M6x50	17	0.72
30 x 60	550	66	60	6	M6x50	17	0.84
32 x 63	580	66	60	6	M6x50	17	1.10
35 x 75	790	83	75	4	M8x60	41	1.40
38 x 75	850	83	75	4	M8x60	41	1.80
40 x 75	900	83	75	4	M8x60	41	1.80
42 x 78	950	83	75	4	M8x60	41	1.90
45 x 85	1520	93	85	6	M8x70	41	1.90
48 x 90	1620	93	85	6	M8x70	41	1.95
50 x 90	1690	93	85	6	M8x70	41	2.00
55 x 94	2470	93	85	8	M8x70	41	2.20
60 x 100	2710	93	85	8	M8x70	41	2.35
65 x 105	2930	93	85	8	M8x70	41	3.65
70 x 115	3770	110	100	6	M10x80	83	3.90
75 x 125	4030	110	100	6	M10x80	83	4.50
80 x 125	4300	110	100	6	M10x80	83	4.30