

NC Joining Module NCFC

Type 2163A...

Weight optimized and compact NC joining module

The NC joining module NCFC Type 2163A... with integrated strain gauge force sensor for joining forces of 55 kN (size 1) and 80 kN (size 2) is specially suitable for force and displacement monitored assembly and joining processes. Weight optimized joining module with lowest installation space for optimum weight and barycentric design at a robot's arm.

- Weight optimized, ideal for robot applications
 - Size 1: 46 kg (without holding brake)
 - Size 2: 66 kg (without holding brake)
- Compact dimensions
- Single cable solution for the servo motor for easiest installation
- High motion speed for short cycle times
- Active deformation compensation for increased positioning precision

Description

The weight optimized housings of the Type 2163A... include a strain gage force sensor with integrated amplifier circuit board. The motion is done by a threaded spindle driven by a servo motor connected via belt drive and gear box. An absolute encoder for precise positioning is integrated in the drive motor. The motor is an electrically commutated AC servo motor which is driven by a servo amplifier.

This servo amplifier provides constant speed, independent of load. Standard functions like block pressing, position pressing and force feedback controlled pressing as well as intermediate positioning are supported. A holding brake for NCFC is available as an option.

The NC joining module NCFC can be operated with the IndraDrive C servo amplifier in combination with maXYmos NC Type 5847. The communication between IndraDrive C and maXYmos NC takes place in real-time via SERCOS III. Several field bus slave interfaces are available onboard for customer controlling. PROFIBUS, PROFINET, EtherNet/IP or even EtherCAT can be used with the maXYmos NC at the customer's choosing. Quality data can be transmitted via the Ethernet interface through different protocols and a visualization via VNC ® or a data backup can be performed.



Application

The NC joining module Type 2163A... is perfectly suitable for the use in automatic assembly lines.

Due to the lightweight and compact design the NCFC is specially suitable for applications with adaptation to a robot's arm, e.g. for clinching and riveting applications.

The fixation of the joining unit to a robot/machine frame is done by a wall mounting.

The alignment of the mechanics in X and Y direction is done by feather key grooves which are identical for both sizes. Therefore an easy exchange of different design sizes is possible. The ram has a centered threaded hole for attaching the customer's tool. An additional centering is integrated.

An inside thread with spigot for tool attachment is in the ram.

2163A_003-541e-03.22

Technical data

Dimensions	mm	see page 3
Assembly options		wall mounting
Max. tool weight ¹⁾ size 1/2		
Without holding brake	kg	25
With holding brake (optional)	kg	25
Direction of measurement		compression
Nominal joining force		
Size 1	kN	0 ... 55
Size 2	kN	0 ... 80
Length of stroke	mm	200
Max. movement speed	mm/s	220 at 55 kN
Max. movement speed	mm/s	200 at 80 kN
Displacement sensor system		absolute encoder
Force sensor		strain gauge
Practical repeatability ⁴⁾	mm	0.01
Short stroke operation		
Size 1	mm	<79
Size 2	mm	<82

¹⁾ Possible radial forces must be considered independent of the mounting.

A bending of the plunger depending on the tool weight must be considered for a horizontal installation.

Service life of spindle (according to defined drive profile)	cycles	approx. 15 million
Temperature range	°C	10 ... 40
Protection class (IEC 60529)		IP54
Lubrication ports		funnel- grease nipples

Servo amplifier ²⁾	Bosch-Rexroth Type 2180A...	
Standard Interface	SERCOS III (internal Bus)	

Evaluation unit ³⁾	maXYmos NC Type 5847...	
Standard Interface	PROFIBUS, PROFINET, EtherNet/IP, EtherCAT	
Power supply	VDC	24 ±5 %

²⁾ Servo amplifier see accessories data sheet 003-125 Type 2180...

³⁾ Evaluation unit maXYmos NC Type 5847B... see data sheet 003-272

⁴⁾ At thermal steady-state

Dimensions NC Joining Module NCFC

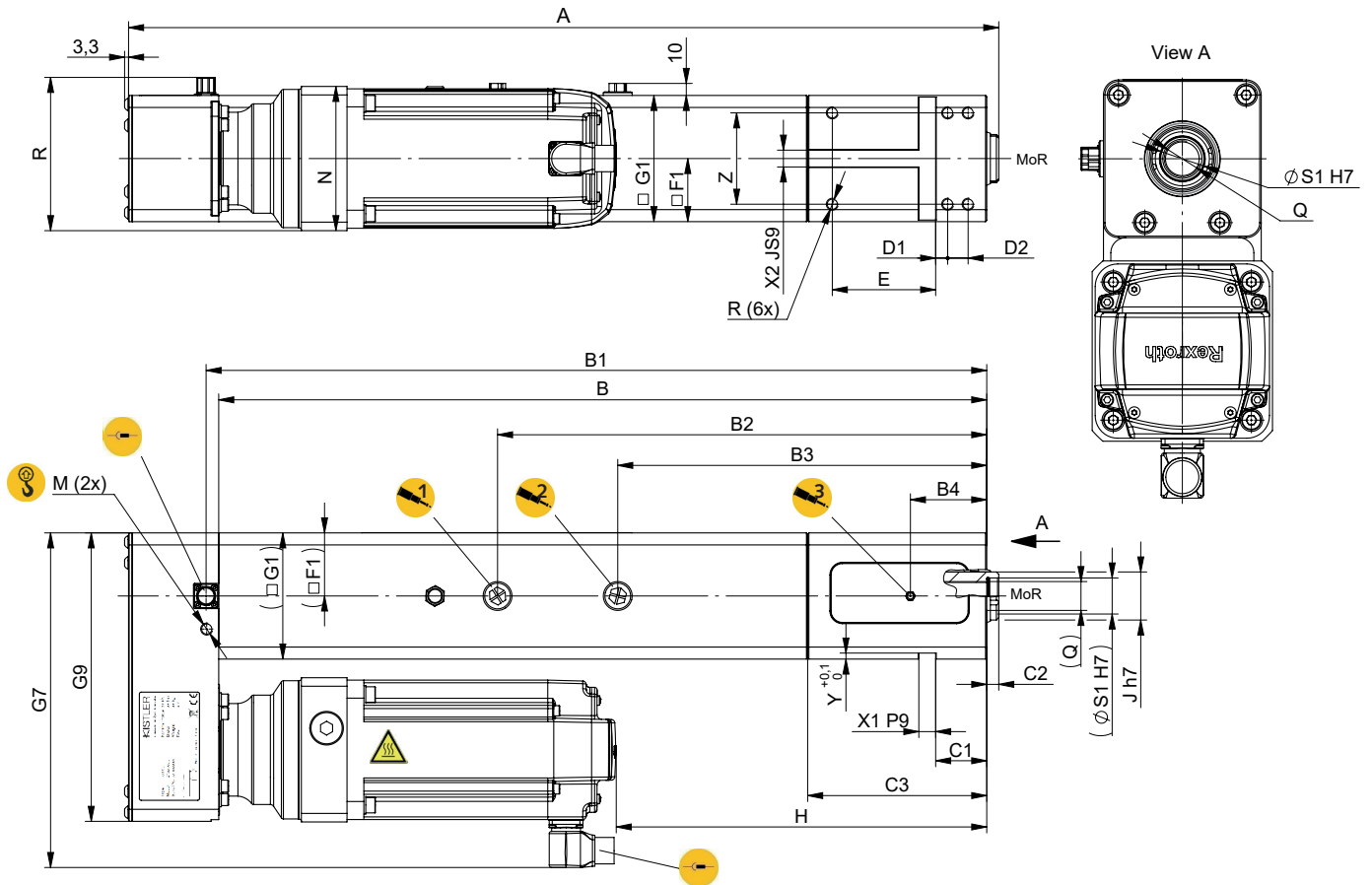







Type 2163A...	A	B	øJ ^{h7}	C2	□G1	□F1	C1	X1 _{P9}	Y ^{+0,1}	C3	X2 ^{JS9}	D1	D2	E	R _(6x)	Z	N	R
...055...	724	639	40	10	105	52,5	42,5	14	5	149	14	10	17	86	M10 Ø20	76	120	127,5
...080...	783,3	697	50	10	125	62,5	42,5	14	5	174	14	10	17	86	M10 Ø20	76	120	140

Type 2163A...	G7	G9	without brake H	with brake H	Q	øS1 ^{H7}	Weight without brake (kg)	Weight with brake (kg)	Thread M _(2x)	B1	B2	B3	B4
...055...	278,4	240	308,25	271,25	M24x1,5 Ø36	30 Ø10	45,6	47,1	M10 Ø20	649,5	407	307	63,5
...080...	296,4	258	327,55	290,55	M24x1,5 Ø36	30 Ø10	65,8	67,3	M10 Ø20	707,5	433,5	333,5	75,5

The radial forces (for example due to the weight of the tool) must be considered for the installation. An external guide may have to be provided for the plunger.

Warnings and notes:

-  Lubrication points for screw drive Position 0 mm
-  Lubrication points for screw drive Position 100 mm
-  Lubrication points for ball bushing 3
-  Electrical connection points
-  Warning high temperatures
-  Attachment points

Functional principle with maXYmos NC Type 5847B...

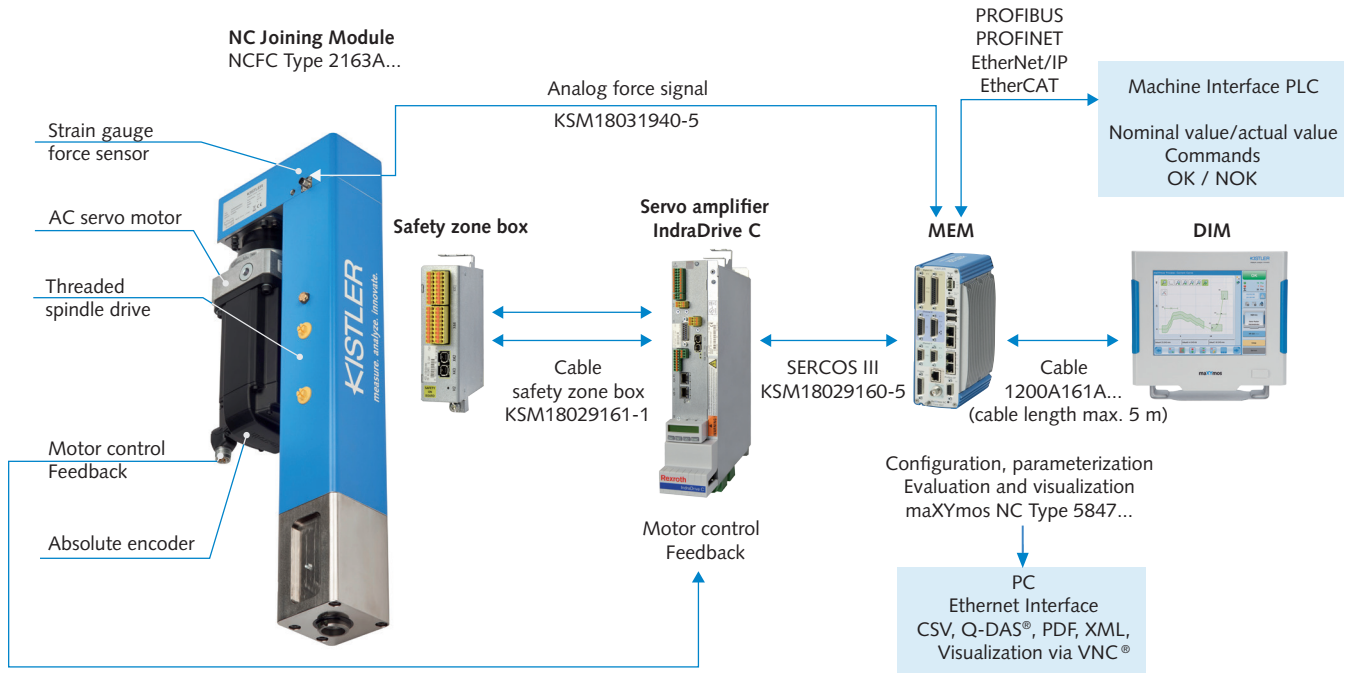

Fig. 1: Functional principle of NC joining system with NC joining module NCFC Type 2163A... and maXYmos NC Type 5847...

Included accessories

- None

Optional accessories

Optional accessories	Type/Art. No.
• Evaluation unit maXYmos NC ⁴⁾ (MEM)	5847...
• Mounting rail adapter for 35 mm cap rail including 2 fastening screws M3x10	5700A31
• Display module (DIM) with pedestal	5877AZ000
• Connection cable maXYmos MEM on DIM, length 5 m	1200A161A5
• Servo amplifier ²⁾	2180A...
• NCFC motor feedback cable hybrid extension cable, length 5 m, for size 1 and 2	1200A253A5
• Force transmitter cable (two parts) Connection to maXYmos NC, length 5 m	KSM18028884-5
Connection to strain gauge force sensor, length 5 m	1200A265-A5
• External fan with mounting bracket for size 1 and 2 (with/without holding brake)	2163AZ001

Cable

- NCFC motor feedback cable hybrid, length 5 m for size 1 1200A249A5
- NCFC motor feedback cable hybrid, length 5 m for size 2 1200A251A5
- Force transmitter cable maXYmos NC to strain gauge force sensor, length 5 m KSM18031940-5
- SERCOS III connection cable, length 5 m KSM18029160-5
- Safety zone box cable, (2 cables required), length 1 m KSM18029161-1

Other cable lengths on request.

Ordering key servo amplifier for NCFC

Power section for NC joining module

NCFC	2163A 55...	NCFC0055
NCFC	2163A 80...	NCFC0080

Safety technology

with safety zone box	SB
----------------------	----

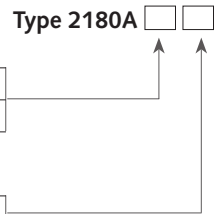

2163A_003-541e-03.22

²⁾ Servo amplifier see accessories data sheet 003-125 Type 2180...

⁴⁾ Evaluation unit maXYmos NC Type 5847B... see data sheet 003-272

Ordering key

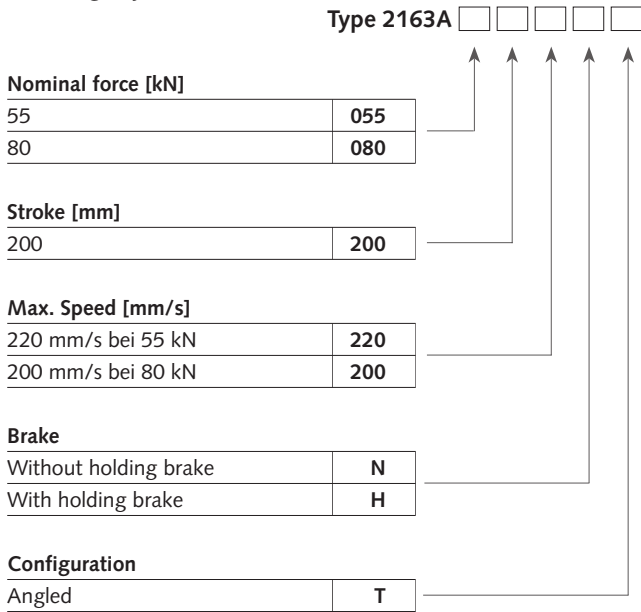

Ordering example **Type 2163A055200220HT**

NC Joining Module NCFC **Type 2163A...**, nominal force **55 kN**, stroke **200 mm**, speed **220 mm/s**, with holding brake **H**, configuration angled **T**

2163A_003-541e-03.22