

# TESTINA PRENSILE

PICK-UP HEAD

TETE DE PREHENSION

GREIFERKOPF

TULIPA

cod. 001.0008 ø 74

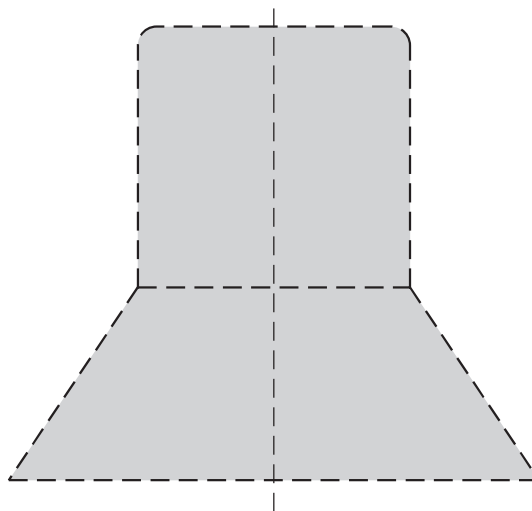
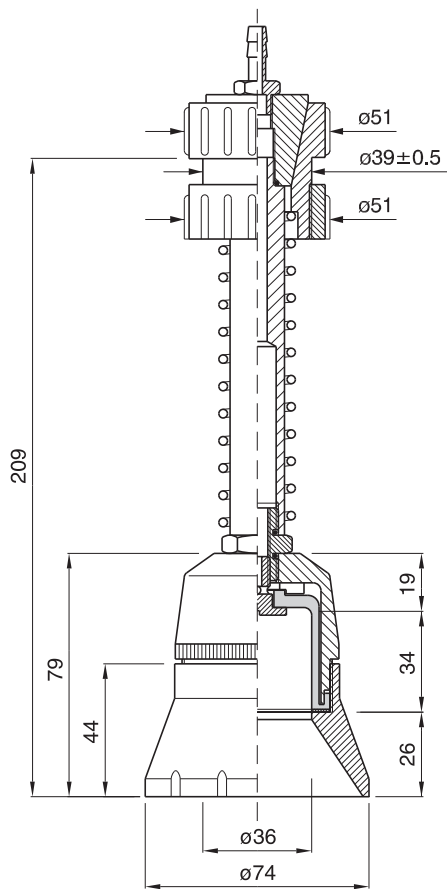

PROFILO INTERNO SCALA 1:1  
INTERNAL SECTION SCALE 1:1  
PROFIL INTERNE ECHELLE 1:1  
INNENPROFIL MASSTAB 1:1  
PERFIL INTERIOR ESCALA 1:1

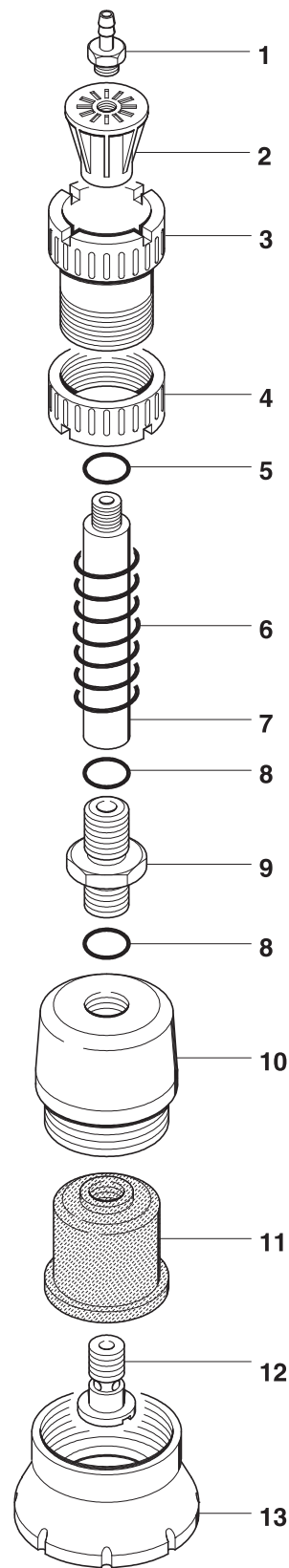

	COD.	MATERIALE	MATERIAL	MATERIEL	WERKSTOFF	MATERIAL
1	024.0001	OTTONE	BRASS	LAITON	MESSING	LATÓN
2	025.0001	PA	PA	PA	PA	PA
3	026.0001	PA	PA	PA	PA	PA
4	026.0011	PA	PA	PA	PA	PA
5	057.0033	GOMMA	RUBBER	CAOUTCHOUC	GUMMI	GOMA
6	029.0001	AISI	STAINLESS STEEL	ACIER INOXYDABLE	ROSTFREIER STAHL	ACERO INOXIDABLE
7	028.0003	AL	AL	AL	AL	AL
8	057.0014	GOMMA	RUBBER	CAOUTCHOUC	GUMMI	GOMA
9	032.0016	OTTONE	BRASS	LAITON	MESSING	LATÓN
10	027.0012	PA	PA	PA	PA	PA
11	040.0056	GOMMA / TPU	RUBBER / TPU	CAOUTCHOUC TPU	GUMMI / TPU	GOMA / TPU
12	032.0001	OTTONE	BRASS	LAITON	MESSING	LATÓN
13	026.0029	PA	PA	PA	PA	PA