

TESTINA PRENSILE

PICK-UP HEAD

TETE DE PREHENSION

GREIFERKOPF

TULIPA

cod. 001.0009 ø 64

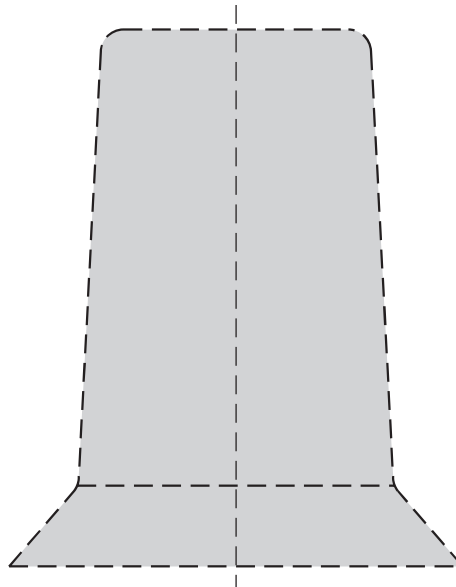
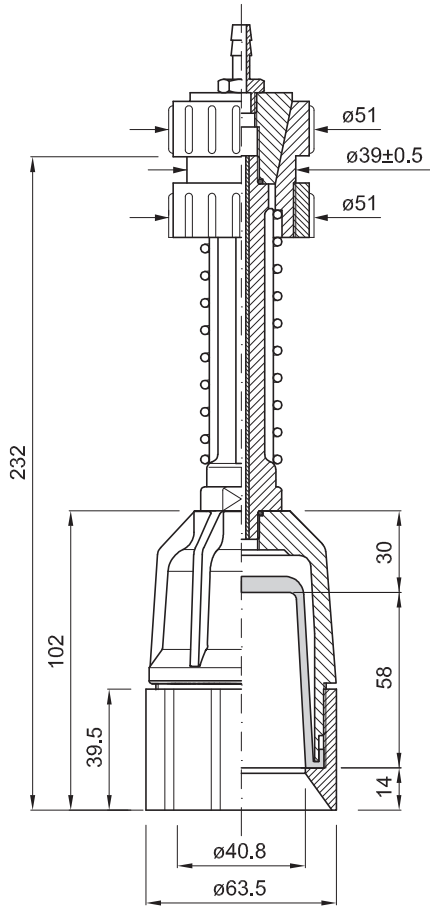

PROFILO INTERNO SCALA 1:1
INTERNAL SECTION SCALE 1:1
PROFIL INTERNE ECHELLE 1:1
INNENPROFIL MASSTAB 1:1
PERFIL INTERIOR ESCALA 1:1

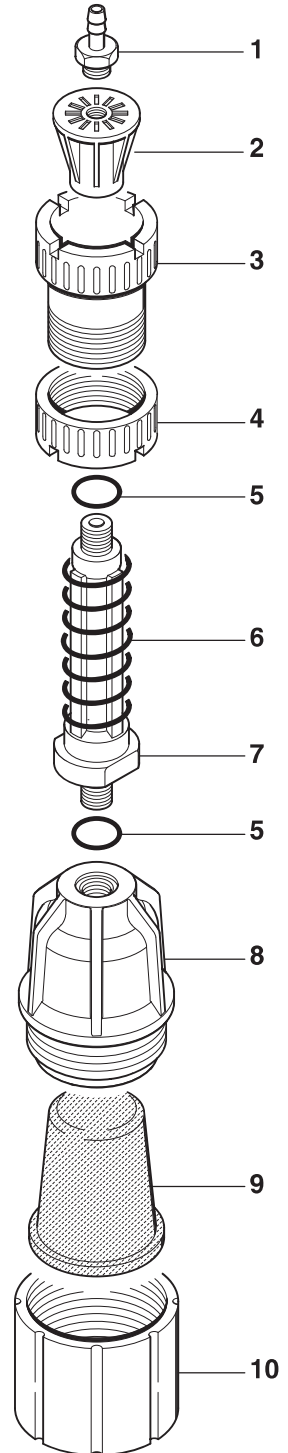

	COD.	MATERIALE	MATERIAL	MATERIEL	WERKSTOFF	MATERIAL
1	024.0001	OTTONE	BRASS	LAITON	MESSING	LATÓN
2	025.0001	PA	PA	PA	PA	PA
3	026.0001	PA	PA	PA	PA	PA
4	026.0011	PA	PA	PA	PA	PA
5	057.0033	GOMMA	RUBBER	CAOUTCHOUC	GUMMI	GOMA
6	029.0001	AISI	STAINLESS STEEL	ACIER INOXYDABLE	ROSTFREIER STAHL	ACERO INOXIDABLE
7	028.0001	PA	PA	PA	PA	PA
8	027.0007	PA	PA	PA	PA	PA
9	040.0006	GOMMA	RUBBER	CAOUTCHOUC	GUMMI	GOMA
10	026.0030	PA	PA	PA	PA	PA