

## Bell suction cup (round)

### SAX 40 ED-85 G1/4-AG

Part no.:10.01.19.00214

<https://www.schmalz.com/10.01.19.00214>

Homepage > Vacuum Technology for Automation > Vacuum Components > Vacuum Suction Cups > Suction Cups for Handling Sheet Metal >

Bell-Shaped Suction Cups SAX > SAX 40 ED-85 G1/4-AG

## Bell suction cup (round) for best adaptation to strongly curved surfaces



Size: 40

Suction cup material: Elastodur

Material hardness: 85 °Sh

Vacuum connection: G1/4"-M

Nipple material: Aluminium

## Design Data

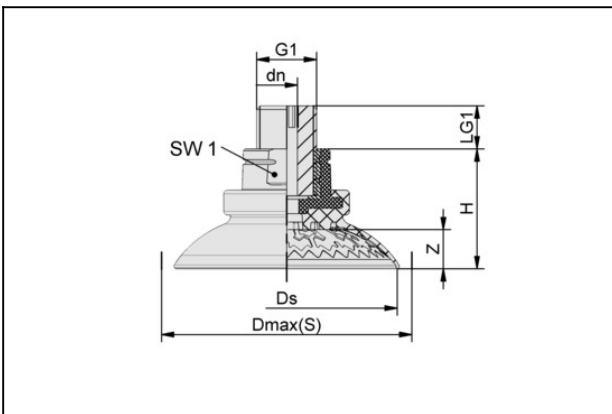

Attribute	Value
dn	6.1 mm
Dmax(S)	45.4 mm
Ds	41.3 mm
G1	G1/4"-M
H	29.3 mm
LG1	14.5 mm
SW1	22 mm
Z (Stroke)	7.1 mm

## Technical Data

### Contact to Schmalz

J. Schmalz GmbH | Johannes-Schmalz-Straße, 72293 Glatten, Deutschland | +49 7443 2403-102 | [customercenter@schmalz.de](mailto:customercenter@schmalz.de)

## Bell suction cup (round)

### SAX 40 ED-85 G1/4-AG

Part no.:10.01.19.00214

<https://www.schmalz.com/10.01.19.00214>



Attribute	Value
Suction force (-600mbar)	69 N
Lateral force	49 N
Lateral force (oily surface)	71 N
Volume	8.5 cm <sup>3</sup>
Curve radius (min) (convex)	25 mm
Size	40
Connection	G1/4"-M
Number of folds	0
Suction cup material	Elastodur
Material hardness [Shore A]	85 Shore A
Weight	33.5 g
Product family	SAX

---

---