

Bellows suction cup HT1 (round)

SAB 50 HT1-60 G1/4-AG

Part no.:10.01.06.03057

<https://www.schmalz.com/10.01.06.03057>

Homepage > Vacuum Technology for Automation > Vacuum Components > Vacuum Suction Cups > Suction Cups for Handling Sheet Metal >

Bellows Suction Cups SAB (1.5 Folds) > SAB 50 HT1-60 G1/4-AG

Bellows suction cup (round) for markless handling of workpieces



Size: 50

Suction cup material:

High temp material HT1

Material hardness: 60 °Sh

Vacuum connection: G1/4"-M

Number of folds: 1.5

Nipple material: Aluminium

Design Data

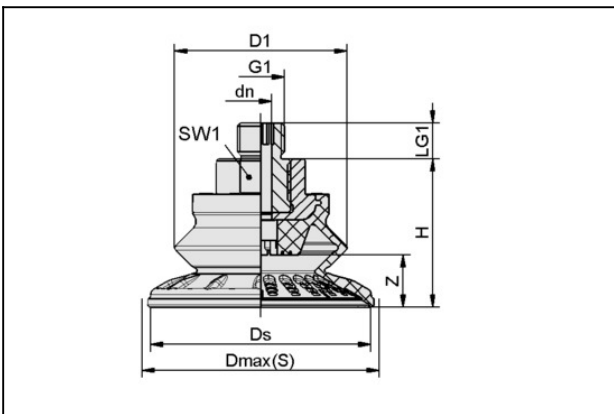

Attribute	Value
dn	6 mm
D1	39.5 mm
Dmax(S)	56 mm
Ds	50.1 mm
G1	G1/4"-M
H	36.9 mm
LG1	10 mm
SW1	22 mm
Z (Stroke)	11.5 mm

Technical Data

Contact to Schmalz

J. Schmalz GmbH | Johannes-Schmalz-Straße, 72293 Glatten, Deutschland | +49 7443 2403-102 | customercenter@schmalz.de

Bellows suction cup HT1 (round)

SAB 50 HT1-60 G1/4-AG

Part no.:10.01.06.03057

<https://www.schmalz.com/10.01.06.03057>



Attribute	Value
Suction force (-600mbar)	53 N
Pull-off force	87 N
Lateral force	55 N
Lateral force (oily surface)	52 N
Volume	11.5 cm ³
Curve radius (min) (convex)	50 mm
Hose diameter (empf.) d	4 mm
Size	50
Number of folds	1.5
Suction cup material	High temp material HT1
Material hardness [Shore A]	60 Shore A
Weight	41.4 g
Product family	SAB

Note: Suction force: The specified suction forces are theoretical values at a vacuum of -0.6 bar and with a smooth, dry workpiece surface - they do not include a safety factor Lateral force: The specified lateral forces are values measured at a vacuum of -0.6 bar with a dry or oily, smooth, flat workpiece surface. Depending on the workpiece surface and its quality, the actual values may deviate from these values Hose diameter: The recommended hose diameter refers to a hose length of approx. 2 m