

External View (Scale1:50)

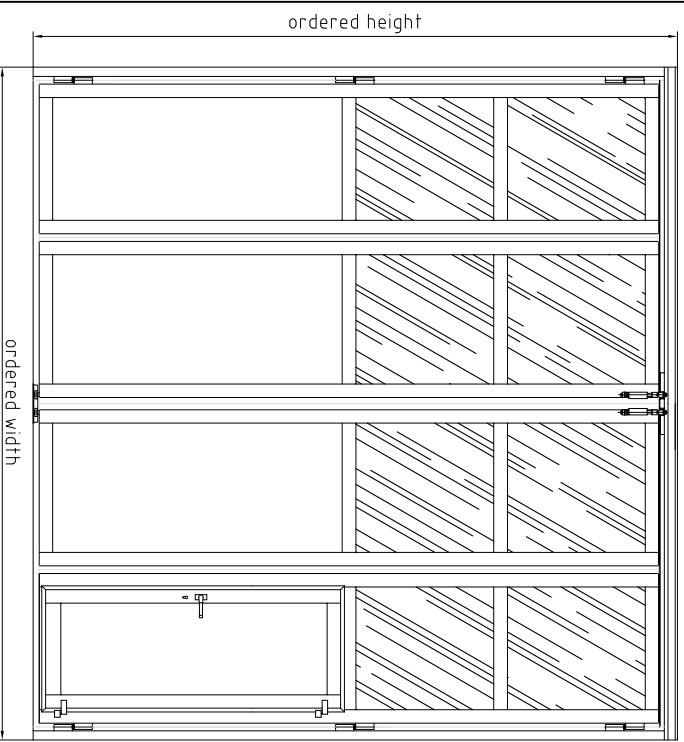

Vertical Cut (Scale1:50)

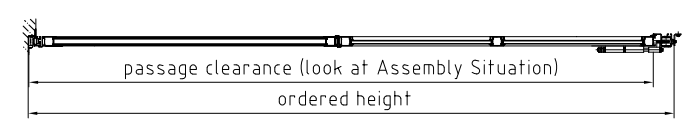

Horizontal Cut (Scale1:50)

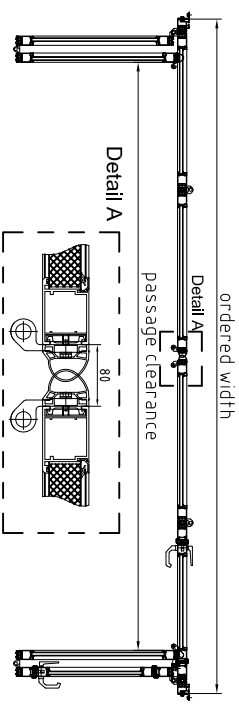

Assembly Situation (Scale1:10)

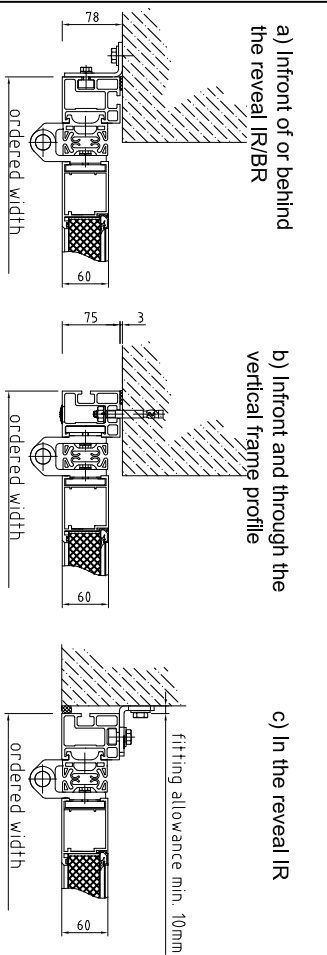

Assembly Situation on the Ledge (Scale1:10)

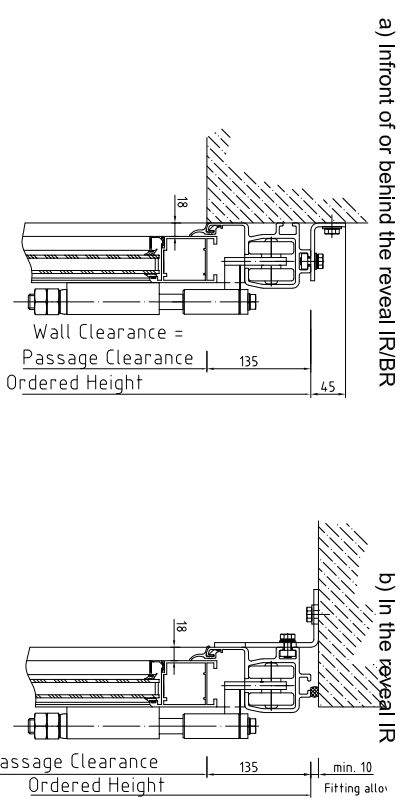

Bottom Details (Scale1:10)

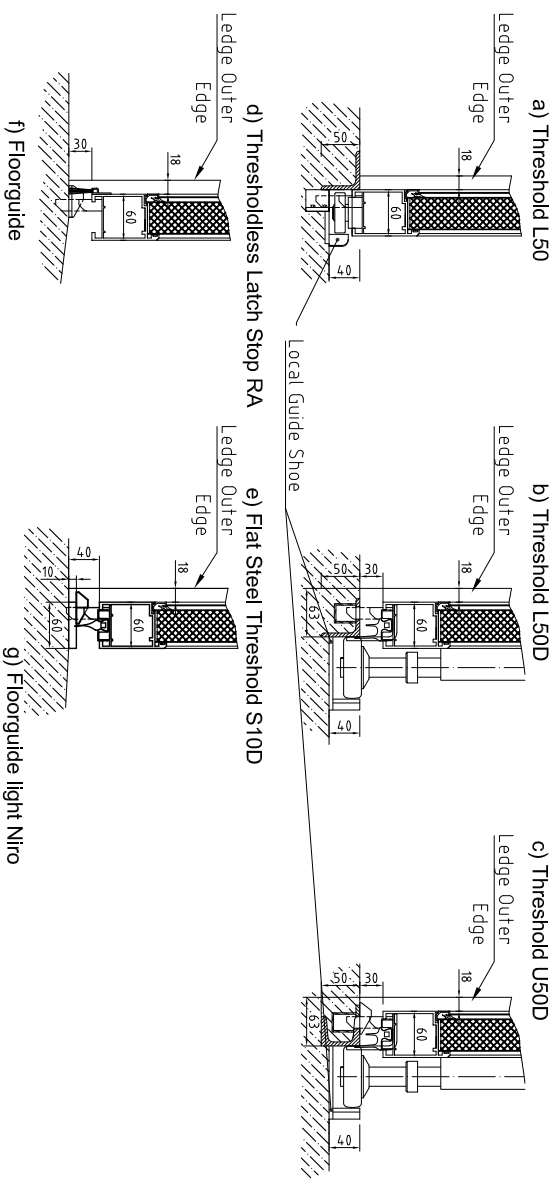

d) Thresholdless Latch Stop RA

e) Flat Steel Threshold S10D

g) Floorguide light Nitro

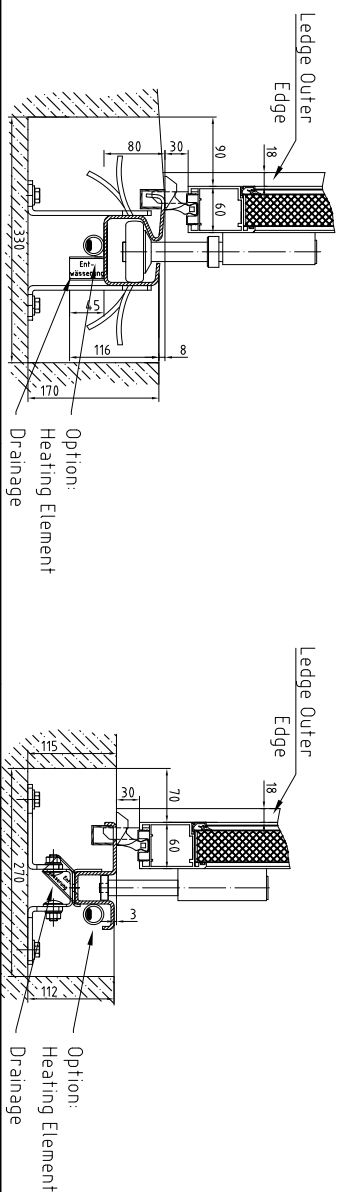

Architectural Sheet

AL602F

SCHNEIDER - Torsysteme GmbH.

A-4611 Bueckrichen, Kalkstrasse 1

Datename: SCH_ARCHITEXTEINBLATT AL602F_2019_08

KR

05.08.2019

